

**PROGRAMMABLE TRANSDUCER  
OF SINGLE-PHASE NETWORK  
PARAMETERS  
WITH RS-485 INTERFACE**

**LUMEL**

**P12P TYPE**



**USER'S MANUAL**

**CE**



## Contents

1. APPLICATION.....	5
2. SET OF THE P12P TRANSDUCER .....	8
3. BASIC REQUIREMENTS, OPERATIONAL SAFETY .....	8
4. INSTALLATION .....	9
5. SERVICING .....	12
6. RS-485 INTERFACE.....	35
7. TECHNICAL DATA.....	54
8. BEFORE A DAMAGE WILL BE SUBMITTED.....	57
9. EXAMPLES OF P12P TRANSDUCER PROGRAMMINGS.....	60
10. OPTION CODES AND ORDERING.....	62
11. MAINTENANCE AND GUARANTEE .....	64



## 1. APPLICATION

The P12P programmable transducer is designed to convert single-network parameters:

a.c. voltage and current, frequency, active, reactive and apparent power (single and three-phase symmetrical network), power factor  $\cos \varphi$ , active power to reactive power ratio, phase shift angle  $\varphi$ , active, reactive, and apparent energy (single and three-phase symmetrical network) into a standard current or voltage signal.

The output is galvanically isolated from the input and supply. The insulation exists also between the current and voltage input.

The P12P transducer is applied as an energy counter in computer systems for internal settlements of accounts.

The P12P transducer is programmed in the factory according to the ordered execution code. The parameter modification is possible with the user through the PD14 programmer, the RS-485 interface or from the keyboard (P12P-2).

The PD14<sup>1)</sup> programmer (ordered separately), serves to program the P11 and P12 transducer families.

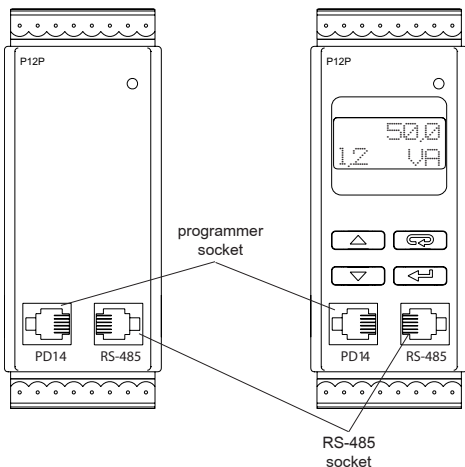
The P12P-2 transducer has an LCD 2 x 8 read-out field.

The P12P transducer realizes following functions:

- conversion of U, I, P, Q, S, Ep, Eq, Es and other calculated quantities into an output signal on the base of the individual linear characteristic,
- recalculation of the input quantity into any indication on the base of the individual linear characteristic,
- programming of alarm outputs,
- signalling of the measuring range exceeding,
- recording of any input signal in programmed time or event recording,
- programming of the indication resolution (only for P12P-2 execution),
- preview of all measuring values and set up parameter values,
- programming of voltage and current ratio,
- zeroing of energy counters,
- storage of all counter states in case of the decay of the supply voltage,
- automatic set-up of the decimal point, (in P12P-2 execution),
- storage of maximal and minimal values of all input quantities,
- programming of the time and kind of measurement averaging: arithmetic mean, walking window,
- display of the unit according to the table 1,
- service of the RS-485 interface in the MODBUS protocol, both in ASCII either in RTU mode,
- data protection by means of a password.

---

<sup>1)</sup> **Note:** The PD14 programmer must be ordered separately.



**Fig.1. View of the P12P transducer: a) P12P-1; b) P12P-2**

The P12P transducer enables processing of:

– The real root-mean-square voltage .....

$$U_{sk} = \sqrt{\frac{1}{n} \sum_{i=1}^n u_i^2}$$

– The real root-mean-square current intensity .....

$$I_{sk} = \sqrt{\frac{1}{n} \sum_{i=1}^n i_i^2}$$

– Frequency .....

$$f = \frac{1}{T}$$

– Active power .....

$$P = U_{sk} \cdot I_{sk} \cdot \cos\varphi$$

- Reactive power .....  $Q = U_{sk} \cdot I_{sk} \cdot \sin\varphi$
- Apparent power .....  $S = U_{sk} \cdot I_{sk}$
- Symmetrical three-phase active power .....  $P_3 = 3 \cdot P$
- Symmetrical three-phase reactive power .....  $Q_3 = 3 \cdot Q$
- Symmetrical three-phase apparent power.....  $S_3 = 3 \cdot S$
- Active energy .....  $E_p = \frac{1}{n} \sum_{i=1}^n aP_i$
- Reactive energy .....  $E_Q = \frac{1}{n} \sum_{i=1}^n aQ_i$ <sup>1)</sup>
- Apparent energy .....  $E_S = \frac{1}{n} \sum_{i=1}^n aS_i$
- Symmetrical three-phase active energy .....  $E_{P3} = 3 \cdot E_p$
- Symmetrical three-phase reactive energy .....  $E_{Q3} = 3 \cdot E_Q$
- Symmetrical three-phase apparent energy .....  $E_{S3} = 3 \cdot E_S$
- Active power factor .....  $\cos\varphi$
- Reactive power to active power ratio .....  $\operatorname{tg}\varphi$
- Phase shift angle .....  $\varphi = f \cdot 360 \cdot T_{UI}$ <sup>2)</sup>

The ratio of the external voltage and current transformers have been taken into consideration in the measurements.

The ratio is freely programmed.

---

<sup>1)</sup>  $a = 1/3600$

<sup>2)</sup>  $T_{UI}$  - time period between current and voltage

## 2. SET OF THE P12P TRANSDUCER

The set is composed of:

- P12P transducer ..... 1 pc.
- Service manual ..... 1 pc.
- Guarantee card ..... 1 pc.
- Plug with screw or self-locking terminals (on order) ..... 3 pcs.
- Hole plug of the programmer socket ..... 2 pcs.

**When unpacking the transducer, please check whether the type and execution code on the data plate correspond to the order code.**

## 3. BASIC REQUIREMENTS AND OPERATIONAL SAFETY

Symbols located in this service manual mean:



– Especially important, one must acquaint with this before connecting the transducer. The non-observance of notices marked by these symbols can occasion the damage of the transducer.



– One must pay attention when the transducer is working contrary to the expectations.

### Remarks concerning the operator safety:



P12P transducers are destined for mounting on 35 mm DIN rails.

In the range of operational safety they are in conformity with the EN 61010-1 standard requirements.

– A qualified personnel should operate the installation and transducer connection.

One must take into consideration all accessible protection requirements.

- Before switching the instrument on, one must check the correctness of the network lead connection.
- In case of the protection terminal connection with a separate lead one must remember to connect it before the connection of network leads.
- Do not connect the instrument to the network through an auto-transformer.
- Before taking the transducer housing out, one must turn the supply off.

- The removal of the transducer housing during the guarantee contract period may cause its cancellation.
- **The programmer socket** is designed for connection the PD14 or PD11 programmer only.
- **The RS-485 socket** is designed for connection devices working with the MODBUS protocol only.
- Place hole plugs into the unused transducer sockets (of the programmer and RS-485).

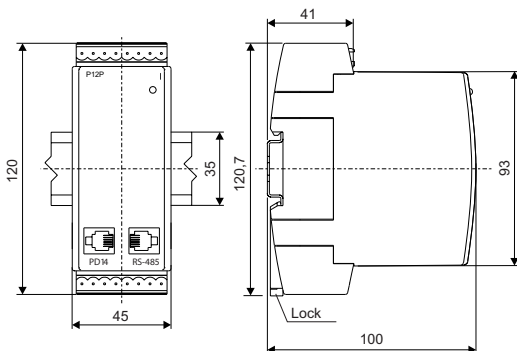
## 4. INSTALLATION

### 4.1. Fitting of the P12P transducer

P12P transducers are designed to be installed on a 35 mm DIN rail acc. DIN EN 50 022-35.

The housing is made of self-extinguishing thermoplastics. The housing dimensions are: 45 x 120 x 100 mm. On the external side of the transducer, there are screw or self-locking terminal strips (on order) enabling the connection of 2.5 mm<sup>2</sup> cross-section conductors.

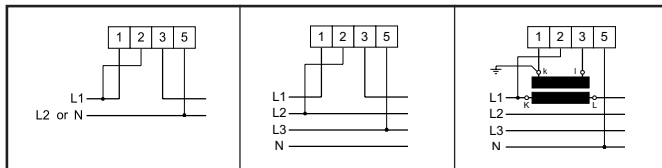
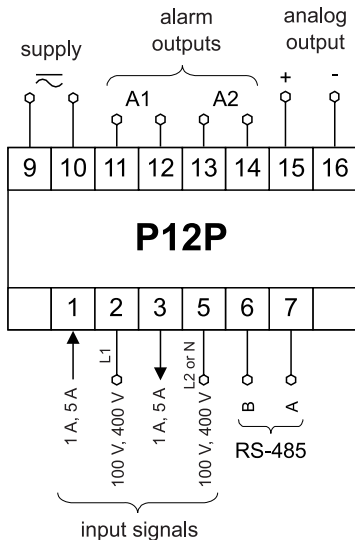
Overall dimensions and the fixing way are shown on the fig.2.



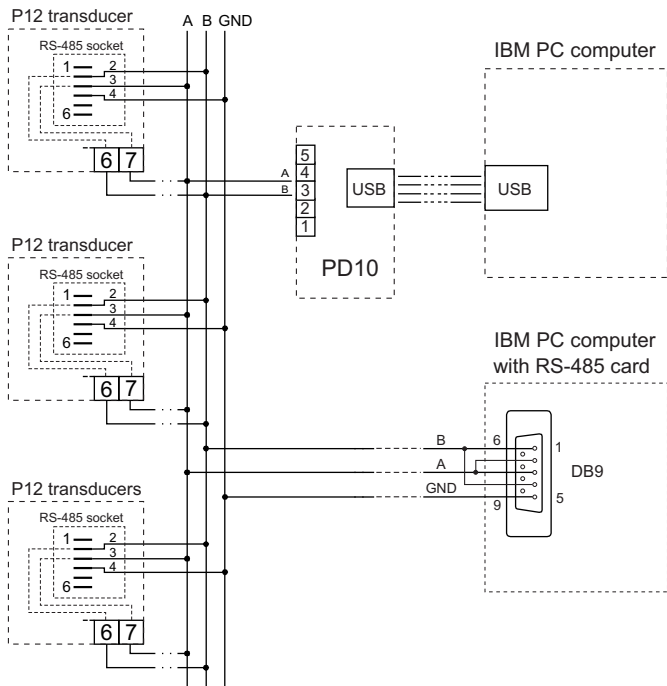
**Fig.2. Overall dimensions and fixing way of P12P transducers.**

## 4.2. External connection diagrams

External connections must be done according Fig.3.



a) Connection way of input signals and exemplary applications



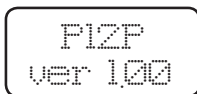
b) Connection way of the RS-485 interface

**Fig.3. External connections of the P12P transducer**

Due to the electromagnetic interference, shielded conductors are recommended, to connect signals of the analogue output. Power supply should be connected by a 2-wire conductor with the proper diameters for ensuring its protection by means of an installation cut-out.

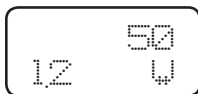
## 5. SERVICING

After connecting external signals and switching the supply on, what is indicated by a lighted LED, the transducer displays the type and the current version of the



program.

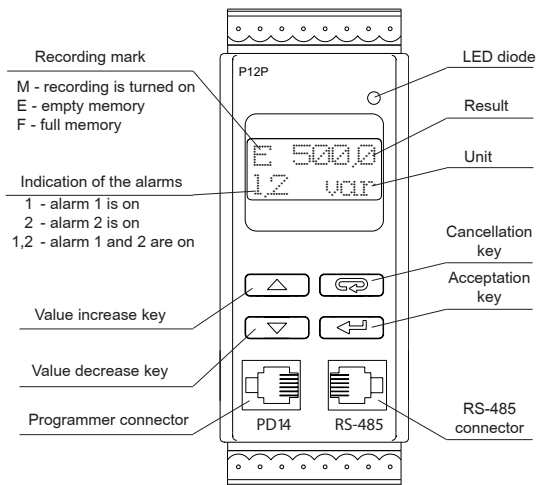
After ca 3s, the transducer automatically transits into the working mode, in which it realizes the measurement and conversion into an analog output signal. It displays the measured value, the unit of the measured or set value by the user and markers of connected alarms.



The transducer blanks automatically void zeros.

The registration switch on is signalled on the display by „E“, „M“ and „F“ letters.

- The „E“ mark means an empty memory and waiting for the registration start - it appears after the exit from the menu when the „Memory“ parameter will be set up (also after switching „Memory“ through the interface).
- The „M“ mark means the duration of the registration - it appears when the conditions to start the registration, after fulfilling the memory, the transducer automatically switches the registration off.
- The „F“ mark means a full memory.



**Fig.4. Description of the P12P transducer frontal plate**

### Key functions:



- acceptance key

- entry into programming mode (hold down ca 3 s),
- entry into the change of the parameter value mode,
- acceptance of the modified parameter value,
- display of the minimum and maximum in the preview menu of the value



- value increase key

- display of the maximal value,
- moving along the preview menu or on the programming matrix,
- modification of the chosen parameter value - value increasing,





- value decrease key



- display of the minimal value,
- moving along the preview menu or on the programming matrix,
- modification of the chosen parameter value - value decreasing,






- cancellation key


- entry into the menu of parameter preview, of recorded value preview, of all measuring value preview with its minimum and maximum (hold down ca 3 s),
- exit from the preview menu or programming matrix,
- cancellation of the parameter change.


Pressing the keys   and holding down within ca 3 s causes the erasing of the alarm indication and/or alarm outputs. This operation works exclusively when the support function is switched on.

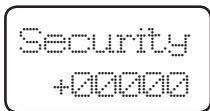
Pressing the keys   causes the erasing of the minimal values of all quantities.





Pressing the keys   causes the erasing of all maximal quantity values.

Pressing the key  during the measurement causes displaying of the maximal value of the currently displayed parameter.

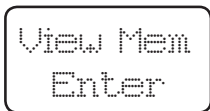
Pressing the key  during the measurement causes displaying of the minimal value of the currently displayed parameter. Releasing the key causes the return to the currently displayed measuring parameter.

Pressing and holding the  key within ca 3 s causes the entry into the programming mode. The programming mode is secured by a security code.

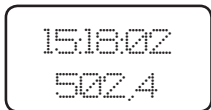





Pressing and holding down the  key within ca 3 s causes the entry into the preview menu. One must move on the preview menu by means of  and  keys. In this menu, all transducer programmable parameters are accessible only for readout, with the exception of servicing parameters. The exit from the preview menu is carried out by means of the  key.

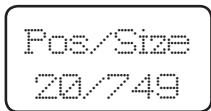
It is possible to review recorded values in the preview menu.



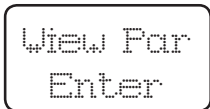
Pressing  key causes the entry into the review menu of the recorded value.







The upper line informs about the sample recording time, whereas the value of the recorded sample is shown on the lower line. Stepping between recorded values happens by  and  keys. Holding down one of these keys for more than 2 s will speed the reviewing. Pressing  key causes displaying of **Pos/Size** inscription, number of sample and total memory used.

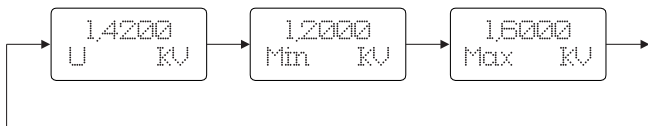


In the preview menu it is also possible to review all measured parameters.



Pressing  key causes the entry into the review menu of measured parameters values. One must move on the menu by means of  and  keys. Pressing  key after the parameter is chosen, causes alternate displaying of the minimum and maximum. Releasing the key causes the return to the displaying of the parameter value.

Active, reactive and apparent energies (1- and 3-phase) do not have neither maximum nor minimum.



The exit from the review of recorded values happens by  key.

The algorithm of the transducer servicing is shown on the Fig.5.

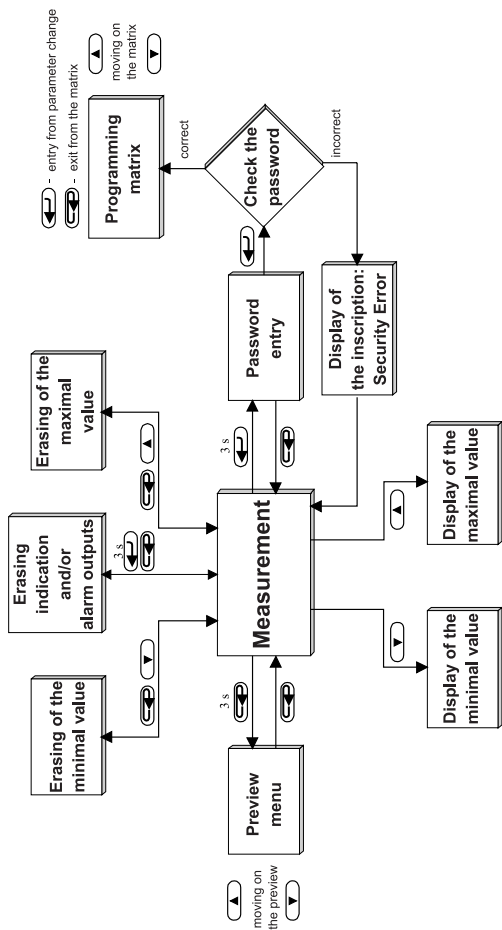
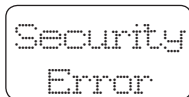


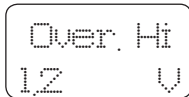
Fig.5. Algorithm of the P12P transducer.

The appearance of mentioned below symbols and inscriptions means:



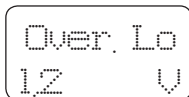
Security  
Error

Incorrectly introduced security code.



Over. Hi  
12 V

Overflow of the higher measuring range.



Over. Lo  
12 V

Overflow of the lower measuring range.

Symbols displayed in the menu, to review measured quantity values, mean:

**U** - Real voltage rsm value

**I** - Real current rsm value

**Fre** - Frequency

**P** - Active power

**Q** - Reactive power

**S** - Apparent power

**P3** - Symmetrical three-phase active power

**Q3** - Symmetrical three-phase reactive power

**S3** - Symmetrical three-phase apparent power

**cos φ** - Power factor

**tg φ** - Reactive to active power ratio

**φ** - Phase shift angle

**Energy P** - Active energy

**Energy Q** - Reactive energy

**Energy S** - Apparent energy

**Ener. P3** - Symmetrical three-phase active energy


**Ener. Q3** - Symmetrical three-phase reactive energy

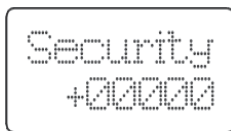
**Ener. S3** - Symmetrical three-phase apparent energy

The change of transducer parameters is possible:

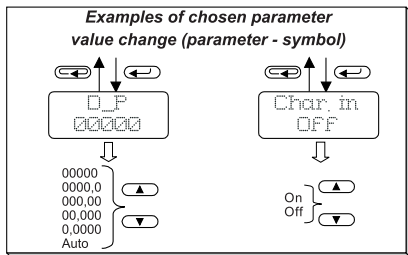
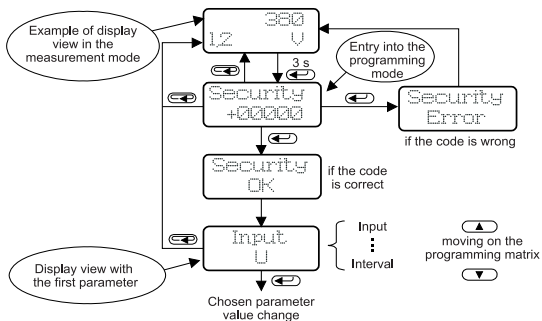
- from the transducer keyboard (in P12P-2) - p 5.1.
- through the PD14 programmer and PC computer - p 5.2.
- through RS-485 - p 6.5.

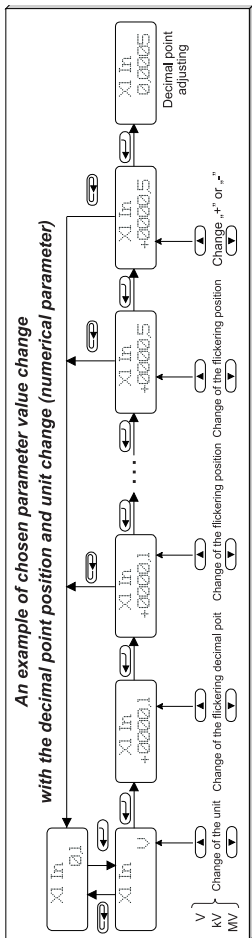
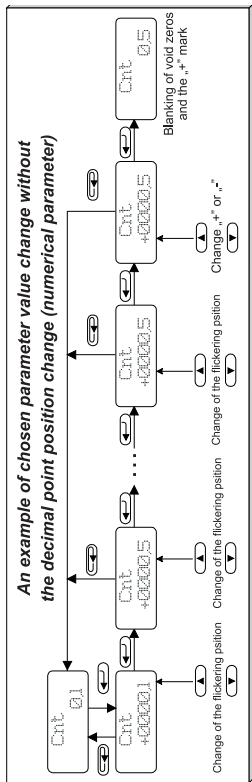
## 5.1. Change of P12P transducer parameters from the keyboard

Pressing  key for ca 3 s causes the display of the inscription **Security** and the set up by the manufacturer, the password value equal zero:



Input of the correct code causes the entry into the programming mode. The programming way is shown below:

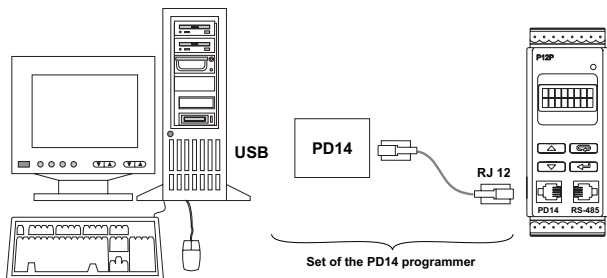




**Fig. 6. Transition matrix in the programming mode**



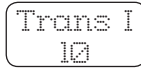

## 5.2. Change of P12P transducer parameters through the PD14 programmer

The way of connection the P12P transducer through the PD14 programmer to the PC computer is shown on the Fig.7. The programmer is connected from one side to the RS-232 port of the PC computer, and from the other one, through a plug of RJ12 type to the P12P transducer.



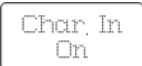
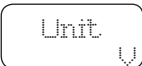


**Fig.7. Connection way of the P12P transducer to the PC computer through the PD14 programmer**

Programmable transducer parameters are specified in the table 1. The programming of the parameters is possible just after the password entry.

	Symbol on the display	Description of parameters	Range of changes
Input parameters		Displayed parameter	<p><b>U</b> - The real root-mean-square voltage</p> <p><b>I</b> - The real root-mean-square current</p> <p><b>Frequen.</b> - Frequency</p> <p><b>P</b> - Active power</p> <p><b>Q</b> - Reactive power</p> <p><b>S</b> - Apparent power</p> <p><b>P3</b> - Symmetrical three-phase active power</p> <p><b>Q3</b> - Symmetrical three-phase reactive power</p> <p><b>S3</b> - Symmetrical three-phase apparent power</p> <p><b>cos φ</b> - Active power ratio</p> <p><b>tg φ</b> - Reactive power to active power ratio</p> <p><b>φ</b> - Phase shift angle</p> <p><b>Energy P</b> - Active energy</p> <p><b>Energy Q</b> - Reactive energy</p> <p><b>Energy S</b> - Apparent energy</p> <p><b>Ener. P3</b> - Symmetrical three-phase active energy</p> <p><b>Ener. Q3</b> - Symmetrical three-phase reactive energy</p> <p><b>Ener. S3</b> - Symmetrical three-phase apparent energy</p>
		Selection of the voltage transformer ratio	Possible settings: <b>0...99999</b> 0 transformer ratio introduction switches the voltage measurement off.
		Selection of the current transformer ratio	Possible settings: <b>0...99999</b> 0 transformer ratio introduction switches the current measurement off.
		Setting of the decimal point. The setting operates either when the individual characteristic is switched off or on. The introduction of the decimal point, which makes impossible the	Possible settings: <b>00000</b> <b>0000.0</b> <b>000.00</b> <b>00.000</b> <b>0.0000</b> <b>Auto</b> - automatic selection of the decimal point

Programmable parameters of the P12P transducer

	<b>Symbol on the display</b>	<b>Description of parameters</b>	<b>Range of changes</b>
<b>Input parameters</b>		display of 7 characters („+“ or „-“, 5 characters for the result, the decimal point character) on the display, will cause the display of the low or upper exceeding.	
		<b>Selection of the averaging measurement</b>	<b>Average</b> - arithmetic average <b>Mov Wind</b> - moving window
		<b>Time of the measurement averaging.</b>	<b>0.0...9999.9 s</b> The input of the <b>0</b> causes the measurement switching off and the stoppage of the transducer work (the LED is switched on). The current time is displayed on the
		The switching off or on the user's individual linear characteristic - (" <b>individual characteristic of the display</b> ")	<b>On</b> - characteristic switched on, <b>Off</b> - characteristic switched off.
		<b>Selection of the unit.</b>	Possible setting: V, A, $\mu$ V, mV, kV, MV, $\mu$ A, mA, kA, MA, mW, W, kW, MW, var, kvar, Mvar, VA, kVA, MVA, $^{\circ}$ C, $^{\circ}$ F, K, Hz, kHz, MHz, mAh, Ah, kAh, Wh, kWh, MWh, m/s, $\mu$ m, mm, cm, m, km, $m^2$ , $m^3$ , $m^2/s$ , $m^2/min$ , $m^2/h$ , $m^3/s$ , $m^3/min$ , $m^3/h$ , l, l/s, l/min, l/h, l/m <sup>2</sup> , l/m <sup>3</sup> , kg/s, kg/min, kg/h, ms, s, h, mN, N, kN, Pa, hPa, kPa, MPa, mmHg, bar, rad, m $\Omega$ , $\Omega$ , k $\Omega$ , M $\Omega$ , G $\Omega$ , %, $^{\circ}$ , turns, rps, rpm, rph, m/h, km/h, GW, Gvar, GVA, GWh, varh, kvarh, Mvarh, Gvarh, VAh, kVAh, MVAh, GVAh, imp, imp/s, imp/m, imp/h.



Input parameters	<div style="border: 1px solid black; padding: 5px; margin-bottom: 5px; text-align: center;">X1 In 0,0000</div> <div style="border: 1px solid black; padding: 5px; margin-bottom: 5px; text-align: center;">Y1 LCD 0,0000</div> <div style="border: 1px solid black; padding: 5px; margin-bottom: 5px; text-align: center;">X2 In 0,0000</div> <div style="border: 1px solid black; padding: 5px; text-align: center;">Y2 LCD 0,0000</div>	<p>Parameters of the individual characteristic of the display.</p> <p>Based on user defined coordinates of two points, the transducer determines (from the system of equations) coefficients <b>a</b> and <b>b</b> of the individual characteristic:</p> $\begin{cases} Y1\ LCD = a \cdot X1\ In + b \\ Y2\ LCD = a \cdot X2\ In + b \end{cases}$ <p>where:</p> <p>X1 In i X2 In - measured value Y1 LCD i Y2 LCD - expected value on the display</p> <p>Fig.9. presents the operation way of the individual characteristic.</p>	<p>For the X1 In and X2 In parameters: Possible settings depend on the input range:</p> <p><b>Frequen., cos φ, tg φ, φ: -99999... 99999</b> <b>U, I: -99999 M ... 99999 M</b> The other input ranges: <b>-99999 G... 99999 G</b></p> <p>For the Y1 LCD i Y2 LCD: Possible settings: <b>-99999...99999</b></p>
------------------	---	--	---

Accessible when the individual characteristic is switched on.

Alarm 1 and Alarm 2 parameters	<div style="border: 1px solid black; padding: 5px; margin-bottom: 5px; text-align: center;">InputAll P</div> <div style="border: 1px solid black; padding: 5px; text-align: center;">InputAl2 Frequen.</div>	<p><b>Kind of the input quantity, which the alarm is to react to.</b></p>	<p><b>U</b> - The real root-mean-square voltage <b>I</b> - The real root-mean-square current <b>Frequen.</b> - Frequency <b>P</b> - Active power <b>Q</b> - Reactive power <b>S</b> - Apparent power <b>P3</b> - Symmetrical three-phase active power <b>Q3</b> - Symmetrical three-phase reactive power <b>S3</b> - Symmetrical three-phase apparent power <b>cos φ</b> - Active power ratio <b>tg φ</b> - Reactive power to active power ratio <b>φ</b> - phase shift angle <b>Energy P</b> - Active energy <b>Energy Q</b> - Reactive energy <b>Energy S</b> - Apparent energy <b>Ener. P3</b> - Symmetrical three-phase active energy <b>Ener. Q3</b> - Symmetrical three-phase reactive energy <b>Ener. S3</b> - Symmetrical three-phase apparent energy</p>
--------------------------------	--	---	---

Programmable parameters of the P12P transducer

Symbol on the display	Description of parameters	Range of changes
<div data-bbox="119 211 305 298">Low A11 0,0</div> <div data-bbox="119 313 305 400">Low A12 200,0</div>	<p><b>Alarming lower threshold</b></p>	<p>Possible settings when the characteristic of the display is switched off: depending on the input range of the given alarm:  <b>Frequen., cos <math>\varphi</math>, tg <math>\varphi</math>, <math>\varphi</math>: -99999... 99999</b>  <b>U, I: -99999 M ... 99999 M</b>                      The other input parameters:  <b>-99999 G... 99999 G</b>                      Possible settings when the characteristic of the display is switched on: <b>-99999...</b></p>
<div data-bbox="119 473 305 560">High A11 20,0</div> <div data-bbox="119 575 305 662">High A12 300,0</div>	<p><b>Alarming upper threshold</b></p>	<p>Possible settings when the characteristic of the display is switched off: depending on the input range of the given alarm:  <b>Frequen., cos <math>\varphi</math>, tg <math>\varphi</math>, <math>\varphi</math>: -99999... 99999</b>  <b>U, I: -99999 M ... 99999 M</b>                      The other input parameters:  <b>-99999 G... 99999 G</b>                      Possible settings when the characteristic of the display is switched on: <b>-99999...</b></p>
<div data-bbox="119 735 305 822">Type A11 Normal</div> <div data-bbox="119 837 305 924">Type A12 On</div>	<p><b>Type of alarm</b>                      Fig.8. presents types of alarms</p>	<p><b>Normal</b> - normal,  <b>On</b> - switched on,  <b>Off</b> - switched off,  <b>Hand On</b> - switched on manually; up to the time of changing the alarm type remains switched on for good,  <b>Hand Off</b> - switched off manually; up to the time of changing the alarm type remains switched off for good.</p>
<div data-bbox="119 997 305 1084">DelayA11 0,0</div> <div data-bbox="119 1099 305 1186">DelayA12 5,0</div>	<p><b>Delay of alarm operation.</b>                      The parameter is defined in seconds, i.e. one must give after how many seconds from its occurrence, the alarm operation will follow. The alarm operation occurs after the measurement averaging. The alarm switching-off follows without delay.</p>	<p><b>0.0...9999.9 s</b>                      The introduction of <b>0.0</b> causes the operation at the moment of the alarm occurrence.</p>

Hold All OFF	<b>The maintenance of the alarm indication.</b>	<b>Off</b> - maintenance switched off, <b>LCD</b> - maintenance of the alarm indication on the display,
Hold All2 Relay	In the situation when the maintenance function is switched on after the withdrawal of the alarm, state on the display and/or the contact state does not change. It signals the alarm state till the moment of its termination by means of the key combination  and  .	<b>Relay</b> - maintenance of the alarm relay, <b>LCD+Rel</b> - maintenance of the alarm indication on the display and of the alarm relay.
InputOut Q	<b>Kind of the input quantity, which is to react at.</b>	<p><b>U</b> - The real root-mean-square voltage  <b>I</b> - The real root-mean-square current  <b>Frequen.</b> - Frequency  <b>P</b> - Active power  <b>Q</b> - Reactive power  <b>S</b> - Apparent power  <b>P3</b> - Symmetrical three-phase active power  <b>Q3</b> - Symmetrical three-phase reactive power  <b>S3</b> - Symmetrical three-phase apparent power  <b>cos φ</b> - Active power ratio  <b>tg φ</b> - Reactive power to active power ratio  <b>φ</b> - Phase shift angle  <b>Energy P</b> - Active energy  <b>Energy Q</b> - Reactive energy  <b>Energy S</b> - Apparent energy  <b>Ener. P3</b> - Symmetrical three-phase active energy  <b>Ener. Q3</b> - Symmetrical three-phase reactive energy  <b>Ener. S3</b> - Symmetrical three-phase apparent energy</p>
CharOut OFF	The switching off or on the user's individual linear characteristic - („ <b>individual characteristic of the analogue output</b> ”).	<p><b>On</b> - characteristic switched on,  <b>Off</b> - characteristic switched off.</p> <p>When the characteristic is switched off, the transducer operates in maximal range depended on kind of the output and input. The analog output, for energy with switched off display characteristic, operates as follows:  0 corresponds to the minimal value on the output,  9999 corresponds to the maximal value on the output</p>

Programmable parameters of the P12P transducer

	<b>Symbol on the display</b>	<b>Description of parameters</b>	<b>Range of changes</b>
<b>Output parameters</b>	X1 LCD 0,0	<p><b>Parameters of the individual characteristic of the analog output.</b></p> <p>Based on user defined coordinates of two points, the transducer determines (from the system of equations) coefficients <b>a</b> and <b>b</b> of the individual characteristic:</p> $\begin{cases} Y1\ Out = a \cdot X1\ LCD + b \\ Y2\ Out = a \cdot X2\ LCD + b \end{cases}$ <p>where                      X1 LCD and X2 LCD - displayed value                      Y1 Out and Y2 Out - expected value on the analog output.                      Fig.9. presents the operation way of the individual characteristic.</p>	<p>For X1 LCD and X2 LCD parameters :                      The setting possibility when the display characteristic is switched off: depending on the input range for the given alarm:  <b>Frequen., cos φ, tg φ, φ: -99999... 99999</b>  <b>U, I: -99 999 M... 99 999 M</b>                      Other input ranges: <b>-99999 G... 99999 G</b></p> <p>The settings possibility when the display characteristic is switched on:  <b>-99999... 99999</b></p> <p>For Y1 Out and Y2 Out parameters:  <b>-999.99... 999.99</b></p>
	Y1 Out. 0,0		
	X2 LCD 0,0		
	Y2 Out 0,0		
	Baud 9600 b/s	<b>Baud rate of the RS-485 interface</b>	2400 b/s 4800 b/s 9600 b/s
	Mode RTU 8N2	<b>Kind of transmission through the RS-485 interface</b>	Off - interface is switched off ASCII 8N1, ASCII 7E1, ASCII 7O1, RTU 8N2, RTU 8E1, RTU 8O1, RTU 8N1
	Address 1	<b>Device address</b>	0...247

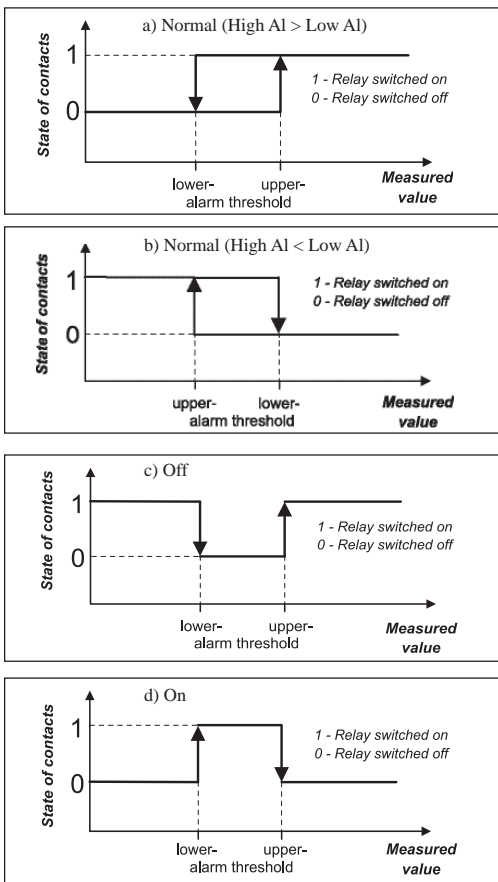
Accessible when the individual characteristic is switched on.

	<b>Factory parameters.</b> Factory parameters are presented in table 2.	Pressing  key causes the restoration of factory parameters.
	<b>Introduction of a new password.</b>	-99999... 99999
	<b>Display test.</b> The display test is expressed by lighting of the first line LCD segments, and next the whole line. The same test is carried out for the second line.	Pressing  key causes the test switching on. Pressing  key ends the test.
	<b>Zeroing of the symmetrical 1-phase and 3-phase active energy.</b>	Pressing  key causes the setting of the counters to zero.
	<b>Zeroing of the symmetrical 1-phase and 3-phase reactive energy.</b>	Pressing  key causes the setting of the counters to zero.
	<b>Zeroing of the symmetrical 1-phase and 3-phase apparent energy.</b>	Pressing  key causes the setting of the counters to zero.
	<b>Setting of actual time and date:</b> Time format: hh:mm:ss Date format: yy.mm.dd Parameters displayed alternately.	00:00:00 ... 23:59:00 70.01.01... 38.12.31

Programmable parameters of the P12P transducer

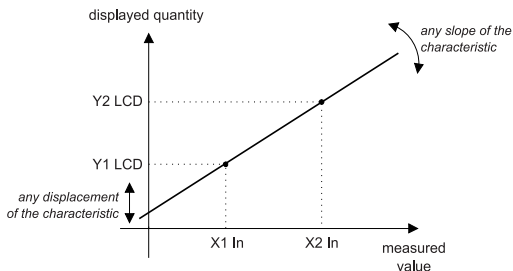
	<b>Symbol on the display</b>	<b>Description of parameters</b>	<b>Range of changes</b>
<b>Recording parameters</b>	InputMem Q	<p><b>Kind of the input quantity, which the recording is to react to.</b></p> <p><b>Caution!</b> The parameter is inaccessible when the recording is switched on.</p>	<p><b>U</b> - The real root-mean-square voltage  <b>I</b> - The real root-mean-square current  <b>Frequen.</b> - Frequency  <b>P</b> - Active power  <b>Q</b> - Reactive power  <b>S</b> - Apparent power  <b>P3</b> - Symmetrical three-phase active power  <b>Q3</b> - Symmetrical three-phase reactive power  <b>S3</b> - Symmetrical three-phase apparent power  <b>cos φ</b> - Active power ratio  <b>tg φ</b> - Reactive power to active power ratio  <b>φ</b> - Phase shift angle  <b>Energy P</b> - Active energy  <b>Energy Q</b> - Reactive energy  <b>Energy S</b> - Apparent energy  <b>Ener. P3</b> - Symmetrical three-phase active energy  <b>Ener. Q3</b> - Symmetrical three-phase reactive energy  <b>Ener. S3</b> - Symmetrical three-phase apparent energy</p>
	Typ Mem down	<p><b>Kind of the recording</b></p> <p><b>Caution!</b> The parameter is inaccessible when the recording is switched on.</p>	<p><b>time</b> - time recording  <b>up</b> - events recording over the set threshold  <b>down</b> - events recording under the set threshold  <b>AI1</b> - recording of the Alarm 1 appearance  <b>AI2</b> - recording of the Alarm 2 appearance</p>
	StartMem 15:18:23	<p><b>Time and date of recording start</b></p> <p>Time format: hh:mm:ss                      Date format: yy.mm.dd                      Parameters are displayed alternately.</p> <p><b>Caution!</b> The parameter is inaccessible when the recording is switched on.</p>	<p><b>00:00:00... 23:59:59</b>  <b>70.01.01...38.12.31</b></p>

Recording parameters	<div style="border: 1px solid black; padding: 5px; display: inline-block;">Interval 01:00:00</div>	<p><b>Recording time interval (when the kind of recording is the time)</b>          Defines time period - how often the result should be saved.</p>	00:00:00 ... 99:59:59
	<div style="border: 1px solid black; padding: 5px; display: inline-block;">EventMem 200,00</div>	<p><b>Event recording threshold, the recording should start from (when the recording kind is: up or down):</b>          up - over the set threshold down - under the set threshold  <b>Caution!</b>          The parameter is inaccessible when the recording is switched on.</p>	<p>It depends on kind of the parameter:  <b>Frequen., cos <math>\varphi</math>, tg <math>\varphi</math>, <math>\varphi</math>: -99999... 99999</b>  <b>U, I: -99 999 M ... 99 999 M</b>          Other input parameters:  <b>-99999 G... 99999 G</b>          The possibility to set up when the display characteristic is switched on the selected parameter: <b>-99999... 99999</b></p>
	<div style="border: 1px solid black; padding: 5px; display: inline-block;">Memory OFF</div>	<p>Erasing and switching the recording on or off.          At the moment of the recording switching on or <b>Clear</b> selection, the transducer erases the previous memorised values after exit from the programming matrix.</p> <div style="border: 1px solid black; padding: 5px; display: inline-block; margin-top: 10px;">Erasing Wait...</div>	<p><b>Off</b> - recording is switched off  <b>On</b> - recording is switched on  <b>Clear</b> - memory erasing  <b>Caution!</b>          The memory erasing does not switch the recording off.          The recording switching on causes the memory erasing.</p>



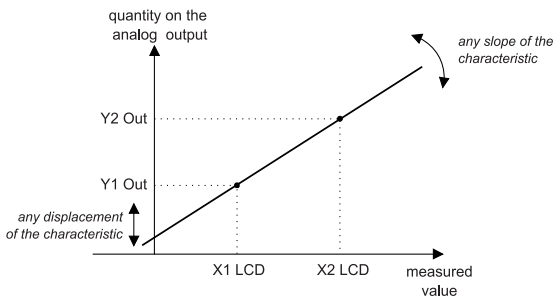
**Fig. 8. Alarm types: a),b) normal c) switched off d) switched on.**

a)



X1 In value on the transducer input => Y1 LCD value on the display  
 X2 In value on the transducer input => Y2 LCD value on the display  
 The other points of the characteristic are calculated.

b)



X1 LCD value on the display => Y1 Out value on the analog output  
 X2 LCD value on the display => Y2 Out value on the analog output  
 The other points of the characteristic are calculated.

**Fig. 9. Individual characteristic: a) of the display b) of the analog output.**



### Caution!

- In case of the display individual characteristic connection, the result on the display is linearly converted according to the introduced **X1 In, X2 In, Y1 LCD** and **Y2 LCD** parameters.
- In case of the analog output individual characteristic connection, the measurement result is linearly converted according to the introduced **X1 LCD, X2 LCD** and **Y1 Out, Y2 Out** parameters.
- The transducer supervises currently the value of the presently introduced parameter. In case when the introduced value overruns the upper or lower range of changes given on the table 1, the transducer will not carry out the parameter recording.
- In case of the **Displayed Parameter** change, a simultaneous change of the unit and decimal point follows, optimally for the given input.
- The registration switching off follows in cases: registration switching off from the programming matrix, setting up Cnt=0, at the renewed switching the transducer on to the network and fulfilling the memory.
- In case of an alarm type **on** or **off** and write the value of the lower alarm threshold higher than the upper alarm threshold, the transcription of the lower alarm threshold into the higher alarm threshold follows and inversely.

In case of write **LowAl=HighAl**:

- for the alarm type **on**, the relay is permanently switched off,
- for the alarm type **off**, the relay is permanently switched on,
- for the alarm type **nor**, the alarm output operates according to the fig. 8a.

### Standard parameters of the P12P transducer

Table 2.

Parameter description	Standard value			
	Ranges 100 V, 1 A	Ranges 100 V, 5 A	Ranges 400 V, 1 A	Ranges 400 V, 5 A
Input	U	U	U	U
Trans U	1	1	1	1
Trans I	1	1	1	1
D_P	0000.0	0000.0	0000.0	0000.0
TypeCnt	Average	Average	Average	Average
ValueCnt	1.0	1.0	1.0	1.0
Char. In	Off	Off	Off	Off
Unit	V	V	V	V
X1 In,Y1 LCD,X2 In,Y2 LCD	0	0	0	0

InputAI1	U	U	U	U
InputAI2	I	I	I	I
Low AI1	0	0	0	0
High AI1	100	100	400	400
Low AI2	0	0	0	0
High AI2	1	5	1	5
Type AI1, Type AI2	Off	Off	Off	Off
DelayAI1, DelayAI2	0	0	0	0
Hold AI1, Hold AI2	Off	Off	Off	Off
InputOut	P	P	P	P
Char.Out	Off	Off	Off	Off
X1 LCD, Y1 Out, X2 LCD, Y2 Out	0	0	0	0
Baud	9600	9600	9600	9600
Mode	RTU 8N2	RTU 8N2	RTU 8N2	RTU 8N2
Address	1	1	1	1
Security	0	0	0	0
Time	00:00:00 70.01.01	00:00:00 70.01.01	00:00:00 70.01.01	00:00:00 70.01.01
InputMem	U	U	U	U
Memory	Off	Off	Off	Off
StartMem	00:00:00	00:00:00	00:00:00	00:00:00
Interval	00:15:00	00:15:00	00:15:00	00:15:00
EventMem	100	100	400	400

## 6. RS-485 INTERFACE

P12 programmable digital transducers have a serial link in the RS-485 standard for the communication in computer systems and with other devices fulfilling the Master function. An asynchronous character MODBUS communication protocol has been implemented on the serial link. The transmission protocol describes the manners of information exchange between devices through the serial link.

### 6.1. Serial interface connection

The RS-485 standard allows the direct connection up to 32 devices on a 1200 m long single serial link. In order to connect a greater number of devices it is necessary to use additional intermediary-separating systems.

The leading out of the interface line is given in the transducer service manual. To obtain a correct transmission it is necessary to connect the lines **A** and **B** in parallel to their equivalents in other devices. The connection must be carried out by means of screened conductors. The screen must be connected to the protective terminal in a single point. The **GND** line serves to the extra protection of the interface line in case of long connections. GND signals should be connected between devices and in one point to the protective terminal (this is not necessary for a correct interface operation).

To obtain the connection with IBM PC class computer, a converter RS-232 into RS-485 of PD10 type or an RS-485 interface card is essential.

The connection way of P12 transducer through a PD10 converter is presented on Fig.3.

The identification of transmission lines for the card in the PC computer depends on the card producer.

### 6.2. Description of the MODBUS implementation

The implemented protocol is in compliance with the specification PI-MBUS-300 Rev G of the Modicon Company.

List of parameters of the transducer serial link in the MODBUS protocol:

- transducer address - 1...247
- baud rate - 2400, 4800, 9600 bit/s
- information unit - ASCII, RTU
- working mode - ASCII: 8N1, 7E1, 7O1  
- RTU: 8N2, 8E1, 8O1, 8N1
- maximal response time - 300 ms

The parameter configuration of the serial link is described in the further part of the service manual. This configuration consists on the settlement of the baud rate (Baud parameter), device address (Address parameter) and the type of the information unit (Mode parameter).

**Note:** Each transducer connected to the communication network must have:

- a unique address , different from the other devices connected to the network.
- the same baud rate and type of the information unit.

### 6.3 Description of the MODBUS protocol functions

In the P12 transducers series the following MODBUS protocol functions are implemented:

**Function description**

**Table 3**

<b>Code</b>	<b>Meaning</b>
03 (03 h)	Read-out of n-register
06 (06 h)	Recording of a single register
16 (10 h)	Recording of n-register
17 (11 h)	Identification of the slave device

The maximal number of registers for writing or recording, in one command, is equal 28.

#### Read-out of n-registers (code 03h)

The function is inaccessible in the broadcasting mode.

**Example:** read-out of 2 registers starting from the register, which the address is 1 DBDh (7613).

Request:

Device address	Function	Register address Hi	Register address Lo	Number of registers Hi	Number of registers Lo	Checksum CRC
01	03	1D	BD	00	02	52 43

Response:

Device address	Function	Number of bits	Register value 1DBD (7613)			Register value 1DBE (7614)			Checksum CRC		
			3F	80	00	00	40	00		00	00
01	03	08	3F	80	00	00	40	00	00	00	42 8B

### Recording of values into the register (code 06h)

The function is accessible in the publication mode.

**Example:** recording of the register which address is 1 DBDh (7613)

Request:

Device address	Function	Register address Hi	Register address Lo	Register value 1DBD (7613)				Checksum CRC
01	06	1D	BD	3F	80	00	00	85 AD

Response:

Device address	Function	Register address Hi	Register address Lo	Register value 1DBD (7613)				Checksum CRC
01	06	1D	BD	3F	80	00	00	85 AD

### Recording into n-registers (code 10h)

The function is accessible in the publication mode.

**Example:** recording of 2 registers starting from the register, which the address is 1 DBDh (7613).

Request:

Device address	Function	Register address Hi	Register address Lo	Number of registers Hi	Number of registers Lo	Number of bits	Value of the register 1DBD (7613)				Value of the register 1DBE (7614)				Checksum CRC
01	10	1D	BD	00	02	08	3F	80	00	00	40	00	00	00	03 09

Response:

Device address	Function	Register address Hi	Register address Lo	Number of registers Hi	Number of registers Lo	Checksum (CRC)
01	10	1D	BD	00	02	D7 80

### Report identifying devices (code 11h)

Request

Device address	Function	Control total (CRC)
01	11	C0 2C

Response

Device address	Function	Number of bits	Device identifier	Device state	Field depending on the device type	Checksum
X	11	08	X	FF	XXXXXX	

<b>Device address</b>	- depending on set value
<b>Function</b>	- number of function 0 x 11
<b>Number of bits</b>	- 0 x 08
<b>Device identifier</b>	- 0 x 71 - P12H - 0 x 72 - P12S - 0 x 74 - P12U - 0 x 73 - P12O - 0 x 79 - P12P
<b>Device state</b>	- 0 x FF
<b>Field depending on the device type</b>	- XXXXXX
Device name	- transmitted as a ASCII character and defines the type of transducer H - 0 x 48,      48 X X X X X S - 0 x 53,      53 X X X X X U - 0 x 55,      55 X X X X X O - 0 x 4F,      4F X X X X X P - 0 x 50,      50 X X X X X
Analogue output	- field depending on the type of the analogue output - 0 x 00 - voltage analog output, X 00 X X X X - 0 x 01 - current analog output, X 01 X X X X
<b>No. of the software version</b>	- software version implemented into the transducer - X X ____ 4-byte variable of the floating type
<b>Checksum</b>	- 2 bytes in case of work in RTU mode - 1 byte in case of work in ASCII mode

### Example:

Work in **RTU** mode, e.g.: **Mode = RTU 8N2** (value 0 x 02 in read/write case through the interface).

**P12P** transducer

Execution with a voltage analog output: **00**,

No. of the software version: **1.00**,

Device address set on: **Address = 0 x 01**,

For such a type of transducer the frame has the following form:

Device address	Funktion	Number of bytes	Device identifier	Device state	Field depending on the device type	Checksum (CRC)
01	11	08	79	FF	50 00 3F 80 00 00	FC 25

## 6.4 P12 transducers' register map

*P12 transducers' register map*

*Table 4.*

<b>Address range</b>	<b>Type value</b>	<b>Description</b>
7000-7200	float (32 bit)	The value is placed in two successive 16-bit registers. Registers enclose the same data as 32-bit registers from the 7500 area. Registers are only for read-out.
7200-7400	float (32 bit)	The value is placed in two successive 16-bit registers. Registers enclose the same data as 32-bit registers from the 7600 area. Registers can be read-out and recorded.
7500-7600	float (32 bit)	The value is placed in a 32-bit register. Registers are only for read-out.
7600-7700	float (32 bit)	The value is placed in a 32-bit register. Registers can be read-out and recorded.

## 6.5 Registers for writing and read-out

### P12P transducer

The value is placed in two successive 16-bit registers. Registers enclose the same data as 32-bit registers from the 7600 area.		The value is placed in a 32-bit register.		Symbol	Writing (w)/Read-out (r)	Range	Description
7200	7600	<b>Identifier</b>	r	-	Device identifier		
					<b>Value</b>		
					0x79h	Identifier	
7202	7601	<b>Input</b>	w/r	0..6	Input type		
					<b>Value</b>		
					0	Effective voltage	
					1	Effective current	
					2	Frequency	
					3	Active power	
					4	Reactive power	
					5	Apparent power	
					6	Calculated 3-phase active power	
					7	Calculated 3-phase reactive power	
					8	Calculated 3-phase apparent power	
					9	Active power factor	
					10	Reactive to active power ratio	
					11	Phase shift	
					12	Active energy	
					13	Reactive energy	
					14	Apparent energy	
					15	Calculated 3-phase active energy	
					16	Calculated 3-phase reactive energy	
					17	Calculated 3-phase apparent energy	

7204	7602		No occurs <sup>1)</sup>			
7206	7603		No occurs <sup>1)</sup>			
7208	7604	<b>Tru</b>	w/r	0... 99999	Transformer voltage ratio	
7210	7605	<b>Tri</b>	w/r	0... 99999	Transformer current ratio	
7212	7606	<b>Aur</b>	w/r	0... 1	Kind of the averaging	
					<b>Value</b>	
					0	Arithmetic average
					1	Moving widow
7214	7607	<b>Ual</b>	z/o	0... 99999	Time of the measurement	
7216	7608		No occurs <sup>1)</sup>			
7218	7609		No occurs <sup>1)</sup>			
7220	7610		No occurs <sup>1)</sup>			
7222	7611		No occurs <sup>1)</sup>			
7224	7612		No occurs <sup>1)</sup>			
7226	7613	<b>D_P</b>	w/r	0... 5	Decimal point	
					<b>Value</b>	
					0	00000
					1	0000.0
					2	000.00
					3	00.000
					4	0.0000
5	automatic selection of the decimal point					
7228	7614		No occurs <sup>1)</sup>			
7230	7615	<b>Char. In</b>	w/r	0... 1	Individual characteristic	
					<b>Value</b>	
					0	Charac. switched off
					1	Charac. switched on
7232	7616	<b>X1 In</b>	w/r	-99999 G... 99999 G <sup>c</sup>	Parameters of the individual characteristic	
7234	7617	<b>Y1 LCD</b>	w/r	-99999... 99999	Parameters of the individual characteristic	
7236	7618	<b>X2 In</b>	w/r	-99999 G... 99999 G	Parameters of the individual characteristic	
7238	7619	<b>Y2 LCD</b>	w/r	-99999... 99999	Parameters of the individual characteristic	

<sup>c</sup> G - Giga = 10<sup>9</sup>

7240	7620	<b>P_a1</b>	w/r	0... 17	Kind of the input quantity, the alarm 1 has to respond to.	
					<b>Value</b>	
					0	Effective voltage
					1	Effective current
					2	Frequency
					3	Active power
					4	Reactive power
					5	Apparent power
					6	Calculated 3-phase active power
					7	Calculated 3-phase reactive power
					8	Calculated 3-phase apparent power
					9	Active power factor
					10	Reactive to active power ratio
					11	Phase shift
					12	Active energy
					13	Reactive energy
					14	Apparent energy
					15	Calculated 3-phase active energy
16	Calculated 3-phase reactive energy					
17	Calculated 3-phase apparent energy					
7242	7621	<b>Low AL1</b>	w/r	-99999 G... 99999 G	Lower threshold of alarm 1	
7244	7622	<b>High AL1</b>	w/r	-99999 G... 99999 G	Upper threshold of alarm 1	
7246	7623	<b>Type AL1</b>	w/r	0... 4	Alarm 1 type	
					<b>Value</b>	
					0	Normal
					1	Switched on
					2	Switched off
					3	Manually switched on
4	Manually switched off					
7248	7624	<b>Delay AL1</b>	w/r	0... 9999.9	Delay of alarm 1	
7250	7625	<b>Hold AL1</b>	w/r	0... 3	Holding of the alarm 1 signalling	
					<b>Value</b>	
					0	Holding switched off
					1	Signalling on LCD

					2	relay holding
					3	Signalling on LCD and relay holding
					To erase the alarm holding, one must switch the holding off(0 value) and then return to the previously set value.	
7252	7626	<b>P_a2</b>	w/r	0... 17	Kind of the input quantity, the alarm 2 has to react to	
					<b>Value</b>	
					0	Effective voltage
					1	Effective current
					2	Frequency
					3	Active power
					4	Reactive power
					5	Apparent power
					6	Calculated 3-phase active power
					7	Calculated 3-phase reactive power
					8	Calculated 3-phase apparent power
					9	Active power factor
					10	Reactive to active power ratio
					11	Phase shift
					12	Active energy
					13	Reactive energy
					14	Apparent energy
					15	Calculated 3-phase active energy
					16	Calculated 3-phase reactive energy
					17	Calculated 3-phase apparent energy
7254	7627	<b>Low AL2</b>	w/r	-99999 G... 99999 G	Lower threshold of alarm 2	
7256	7628	<b>High AL2</b>	w/r	-99999 G... 99999 G	Upper threshold of alarm 2	
7258	7629	<b>Type AL2</b>	w/r	0... 4	Alarm 2 type	
					<b>Value</b>	
					0	Normal
					1	Switched on
					2	Switched off
					3	Manually switched on
					4	Manually switched off
7260	7630	<b>Delay AL2</b>	w/r	0... 9999.9	Delay of the alarm 2	

7262	7631	<b>Hold AL2</b>	w/r	0... 3	Holding of the alarm 2 signalling	
					<b>Value</b>	
					0	Holding switched off
					1	Signalling on LCD
					2	Signalling on LCD
					3	Signalling on LCD and relay holding
					To erase the alarm holding, one must switch the holding off(0 value) and then return to the previously set value.	
7264	7632	<b>Memory</b>	w/r	0... 2	Memory erasing, switching off or on	
					<b>Value</b>	
					0	Recording switched off
					1	Recording switched on
					2	Memory erasing
					<b>Caution!</b> The memory erasing does not stop the recording. The recording switching on causes the memory erasing. At the moment of the recording switching on or <b>Clear</b> selection, the transducer erases the previous memorized values	
7266	7633	<b>Mem. input</b>	w/r	0... 17	Kind of the input quantity, which is to be recorded	
					<b>Value</b>	
					0	Effective voltage
					1	Effective current
					2	Frequency
					3	Active power
					4	Reactive power
					5	Apparent power
					6	Calculated 3-phase active power
					7	Calculated 3-phase reactive power
					8	Calculated 3-phase apparent power
					9	Active power factor
					10	Reactive to active power ratio
					11	Phase shift
					12	Active energy
					13	Reactive energy
					14	Apparent energy
					15	Calculated 3-phase active energy
					16	Calculated 3-phase reactive energy
17	Calculated 3-phase apparent energy					
					<b>Caution!</b> The parameter is inaccessible when the recording is switched on.	

7268	7634	<b>P_an</b>	w/r	0... 17	Kind of the input quantity, which the analog input is to react to	
					<b>Value</b>	
					0	Effective voltage
					1	Effective current
					2	Frequency
					3	Active power
					4	Reactive power
					5	Apparent power
					6	Calculated 3-phase active power
					7	Calculated 3-phase reactive power
					8	Calculated 3-phase apparent power
					9	Active power factor
					10	Reactive to active power ratio
					11	Phase shift
					12	Active energy
					13	Reactive energy
					14	Apparent energy
					15	Calculated 3-phase active energy
16	Calculated 3-phase reactive energy					
17	Calculated 3-phase apparent energy					
7270	7635	<b>Char.Out</b>	w/r	0... 1	Characteristic of the analog output	
					<b>Value</b>	
					0	Charac. switched off
					1	Charac. switched on
7272	7636	<b>X1 LCD</b>	w/r	-99999 G... 99999 G	Displayed lower value	
7274	7637	<b>Y1 Out</b>	w/r	-99999... 99999	Lower value of the analog output	
7276	7638	<b>X2 LCD</b>	w/r	-99999 G... 99999 G	Displayed upper value	
7278	7639	<b>Y2 Out</b>	w/r	-99999... 99999	Upper value of the analog output	
7280	7640	<b>Time</b>	w/r	0... 23.5959	Current time	
					This parameter occurs with four places after the decimal point, in the format gg.mmss, where: gg - means hours, mm - means minutes, ss - means seconds. In case of a wrong time introduction, the transducer will correct it automatically. <b>Caution!</b> The parameter is inaccessible when the recording is switched on	
7282	7641	<b>Unit</b>	w/r	0... 80 <sup>2)</sup>	Unit choice	

7284	7642	<b>Mem. type</b>	w/r	0... 4	Recording type	
					<b>Value</b>	
					0	Time recording
					1	Events recording over the set threshold
					2	Events recording under the set threshold
					3	Recording of the alarm 1 appearance
					4	Recording of the alarm 2 appearance
					<i>Caution!</i> The parameter is inaccessible when the recording is switched on.	
7286	7643	<b>Interval</b>	w/r	0... 99.5959	Time period of the recording	
					<i>Caution!</i> The parameter is inaccessible when the recording is	
7288	7644	<b>Year</b>	w/r	1970... 2038	Year of the recording start	
					<i>Caution!</i> The parameter is inaccessible when the recording is	
7290	7645	<b>Month</b>	w/r	1... 12	Months of the recording start	
					<i>Caution!</i> The parameter is inaccessible when the recording is	
7292	7646	<b>Day</b>	w/r	1... 31	Day of the recording start	
					<i>Caution!</i> The parameter is inaccessible when the recording is	
7294	7647	<b>Mem. start</b>	w/r	1... 23.5959	Time of the recording start	
					This parameter occurs with four places after the decimal point, in the format gg.mmss, where: gg - means hours, mm - means minutes, ss - means seconds. In case of a wrong time introduction, the transducer will correct it automatically.	
					<i>Caution!</i> The parameter is inaccessible when the recording is	
7296	7648	<b>Del.Min</b>	w/r	0... 1	Erasing of minimal values	
					<b>Value</b>	
					0	No operation
					1	Erasing of the minimal value
7298	7649	<b>Del.Max</b>	w/r	0... 1	Erasing of the maximal value	
					<b>Value</b>	
					0	No operation
					1	Erasing of the maximal value
7300	7650			No occurs <sup>1)</sup>		

7302	7651	<b>ClrP</b>	w/r	0... 1	Zeroing of the symmetrical 1- and 3-phase active energy	
					<b>Value</b>	
					0	No operation
					1	Zeroing of the symmetrical 1- and 3-phase active energy
7304	7652	<b>ClrQ</b>	w	0... 1	Zeroing of the symmetrical 1- and 3-phase reactive energy	
					<b>Value</b>	
					0	No operation
					1	Zeroing of the symmetrical 1- and 3-phase reactive energy
7306	7653	<b>ClrS</b>	w	0... 1	Zeroing of the symmetrical 1- and 3-phase apparent energy	
					<b>Value</b>	
					0	No operation
					1	Zeroing of the symmetrical 1- and 3-phase apparent energy
7308	7654	<b>Current year</b>	w/r	1970... 2038	Current year	
7310	7655	<b>Current month</b>	w/r	1... 12	Current months	
7312	7656	<b>Current day</b>	w/r	1... 31	Current day	
7314	7657	<b>Recording threshold</b>	w/r	-99999 G... 99999 G	Threshold of the recording start	
					<b>Caution!</b> The parameter is inaccessible when the recording is	
7320	7660	Year of the stored value	w/r	1970... 2038	Year of the stored value in the memory	
7322	7661	Month of the stored value	w/r	1... 12	Month of the stored value in the memory	
7324	7662	Day of the stored value	w/r	1... 31	Day of the stored value in the memory	
7326	7663	Time of the stored value	w/r	0... 23.5959	Time of the stored value in the memory	
					This parameter occurs with four places after the decimal point, in the format gg,mm,ss, where: gg - means hours, mm - means minutes, ss - means seconds. In case of a wrong time introduction, the transducer will correct it automatically.	

7328	7664	Index of the stored value	w/r	1... 750	Number of the stored value in the memory		
7330	7665	Status	w/r	0... 7	Status of the operation in the buffer		
					<b>Value</b>		
					0	No operation	
					1	Search acc. to the date and time (registers 7660...7663 and 7320...7326)	
					2	Search acc. to the time (registers 7663 and 7326)	
					3	Search acc. to the index (registers 7664 and 7328)	
					4	Load next values in to the buffer (registers 7672...7691 and 7344...7382)	
					5	Load previous values in to the buffer (registers 7672...7691 and 7344...7382)	
					6	Go to the first stored value in the memory	
7	Go to the last stored value in the memory						
7332	7666	Number of the stored value	r	0... 750	Number of the stored value into the memory, placed in the first buffer register		
					<b>Value</b>		
					0	The memory is empty	
					1...750	Number of the stored value	
7334	7667	Number of recorded register	r	0... 750	Number of the recorded buffer registers		
					<b>Value</b>		
					0	The buffer is empty	
					1...750	Number of the recorded registers	
7336	7668	Year	r	1970... 2038	Year for the value in the first register		
7338	7669	Month	r	1... 12	Month for the value in the first register		
7340	7670	Day	r	1... 31	Day for the value in the first register		
7342	7671	Time	r	0... 23.5959	Time for the value in the first register		
					This parameter occurs with four places after the decimal point, in the format gg.mmss, where: gg - means hours, mm - means minutes, ss - means seconds.		

7344...7382	7672... 7691	Buffer	r	-	Stored values, read-out from the memory
					20 registers, containing 20 stored values

<sup>1)</sup> In case of registers no occurring in the given transducer series, their value is  $1E + 20$

<sup>2)</sup> Unit values

Code	Unit	Code	Unit	Code	Unit	Code	Unit
0	V	25	MHz	50	l/m <sup>2</sup>	75	turns
1	A	26	mAh	51	l/m <sup>3</sup>	76	rps
2	μV	27	Ah	52	kg/s	77	rpm
3	mV	28	kAh	53	kg/min	78	rph
4	KV	29	Wh	54	kg/h	79	m/h
5	MV	30	kWh	55	ms	80	km/h
6	μA	31	MWh	56	s	81	GW
7	mA	32	m/s	57	h	82	Gvar
8	kA	33	μm	58	mN	83	GVA
9	MA	34	mm	59	N	84	GWh
10	mW	35	cm	60	kN	85	
11	W	36	m	61	Pa	86	varh
12	kW	37	km	62	hPa	87	kvarh
13	MW	38	m <sup>2</sup>	63	kPa	88	Mvarh
14	var	39	m <sup>3</sup>	64	MPa	89	Gvarh
15	kvar	40	m <sup>2</sup> /s	65	mmHg	90	VAh
16	Mvar	41	m <sup>2</sup> /min	66	bar	91	kVAh
17	VA	42	m <sup>2</sup> /h	67	rad	92	MVAh
18	kVA	43	m <sup>3</sup> /s	68	mOhm	93	GVAh
19	MVA	44	m <sup>3</sup> /min	69	Ohm	94	imp
20	°C	45	m <sup>3</sup> /h	70	kOhm	95	imp/s
21	°F	46	l	71	MOhm	96	imp/m
22	K	47	l/s	72	GOhm	97	imp/h
23	Hz	48	l/min	73	%		
24	kHz	49	l/h	74	°		

## 6.6. Registers only for read-out

### P12P transducer

The value is placed in two successive 16-bit registers. Registers enclose the same data as 32-bit registers from the 7500 area.	The value is placed in a 32-bit registers	Name	Writing(w)/read-out(r)	Unit	Name of the quantity
7000	7500	<b>Identifier</b>	0	-	Constant identifying the device
					0x71 - P12H 0x72 - P12S 0x74 - P12U 0x73 - P12O 0x79 - P12P
7002	7501	<b>Status</b>	0	-	Status is the register describing the transducer current state
7004	7502	<b>Steering</b>	0	%	It is the register defining the steering of the analog output. It is the value in % reported to the output characteristic. $\text{Steering} = \frac{\text{result} - Y1Out}{Y2Out - Y1Out} \cdot 100 [\%]$
7006	7503	<b>Min</b>	0	-	Minimal value of the currently measured value
7008	7504	<b>Max</b>	0	-	Maximal value of the currently measured value
7010	7505	<b>Measured value</b>	0	-	Currently measured value on the transducer
7012	7506	No occurs 1)			
7014	7507	<b>Hour</b>	0	gg,mmss	Current time
7016	7508	No occurs 1)			
7018	7509	U	0	V	Effective voltage
7020	7510	I	0	A	Effective current
7022	7511	Freq	0	Hz	Frequency
7024	7512	P	0	W	Active power
7026	7513	Q	0	Var	Reactive power
7028	7514	S	0	VA	Apparent power

7030	7515	P3	0	W	Calculated 3-phase active power
7032	7516	Q3	0	Var	Calculated 3-phase reactive power
7034	7517	S3	0	VA	Calculated 3-phase apparent power
7036	7518	PF	0		Active power factor
7038	7519	tF	0		Reactive to active power ratio
7040	7520	Fi	0	°	Phase shift
7042	7521	E_nP	0	Wh	Active energy
7044	7522	E_nQ	0	Varh	Reactive energy
7046	7523	E_nS	0	VAh	Apparent energy
7048	7524	E_nP3	0	Wh	Calculated 3-phase active energy
7050	7525	E_nQ3	0	Varh	Calculated 3-phase reactive energy
7052	7526	E_nS3	0	VAh	Calculated 3-phase apparent energy
7054	7527	Hour	0	gg.mmss	Current time
7056	7528	U_min	0	V	Minimal value of the effective voltage
7058	7529	U_max	0	V	Maximal value of the effective voltage
7060	7530	I_min	0	A	Minimal value of the effective current
7062	7531	I_max	0	A	Maximal value of the effective current
7064	7532	Freq_min	0	Hz	Minimal value of the frequency
7066	7533	Freq_max	0	Hz	Maximal value of the frequency
7068	7534	P_min	0	W	Minimal value of the active power
7070	7535	P_max	0	W	Maximal value of the active power
7072	7536	Q_min	0	Var	Minimal value of the active power
7074	7537	Q_max	0	VAr	Minimal value of the reactive power
7076	7538	S_min	0	VA	Maximal value of the reactive power
7078	7539	S_max	0	VA	Minimal value of the apparent power
7080	7540	P_min3	0	W	Calculated minimal value of the 3-phase active power
7082	7541	P_max3	0	W	Calculated maximal value of the 3-phase active power
7084	7542	Q_min3	0	Var	Calculated minimal value of the 3-phase reactive power
7086	7543	Q_max3	0	Var	Calculated maximal value of the 3-phase reactive power
7088	7544	S_min3	0	VA	Calculated minimal value of the 3-phase apparent power
7090	7545	S_max3	0	VA	Calculated maximal value of the 3-phase apparent power
7092	7546	PF_min	0		Minimal value of the active power factor
7094	7547	PF_max	0		Maximal value of the active power factor
7096	7548	tF_min	0		Minimal value of the reactive to active power ratio

7098	7549	tF_max	0		Maximal value of the reactive to active power ratio
7100	7550	Fi_min	0	°	Minimal value of the phase shift
7102	7551	Fi_max	0	°	Maximal value of the phase shift

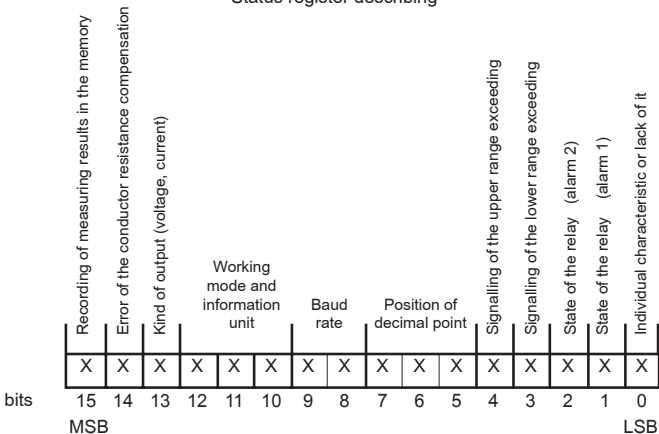
1) In case of registers no occurring in the given transducer series, their value is  $1E + 20$

### Caution!

While exceeding the upper or the lower parameter range, „displayed value“, „minimum“, „maximum“ are set on the  $1E + 20$  value.

For **Cnt**=0 parameter (measurement switching off), „minimum“, „maximum“ parameters and „displayed value“ are set on the  $1E + 20$  value.

### Status register describing



#### Bit-15 Recording of the measurement results in the memory

0 - recording switched off

1 - recording switched on

#### Bit-14 Error of the conductor resistance compensation

0 - lack of error

1 - signalling of the compensation error

### Caution!

This bit is set only in P12U transducer. For other types of P12 transducer executions, the value of this bit is free.

**Bit-13 Kind of output (voltage, current)**

0 - voltage

1 - current

**Bit-10...12 Working mode and information unit**

000 - interface switched off

001 - 8N1 - ASCII

010 - 7E1 - ASCII

011 - 7O1 - ASCII

100 - 8N2 - RTU

101 - 8E1 - RTU

110 - 8O1 - RTU

111 - 8N1 - RTU

**Bit-8...9 Baud rate**

00 - 2400 bit/s

01 - 4800 bit/s

10 - 9600 bit/s

**Bit-5...7 Position of decimal point (concerns the switched individual characteristic on)**

000 - lack

001 - 0.0

010 - 0.00

011 - 0.000

100 - 0.0000

101 - Auto

**Bit-4 Signalling of the upper overrunning of the range**

0 - normal work

1 - range overrunning

**Bit-3 Signalling of the lower overrunning of the range**

0 - normal work

1 - range overrunning

**Bit-2 Relay (alarm) 2 state**

0 - switched off

1 - switched on

**Bit-1 Relay (alarm) 1 state**

0 - switched off

1 - switched on

**Bit-0 Individual characteristic**

0 - individual characteristic switched off

1 - individual characteristic switched on

## 7. TECHNICAL DATA

### INPUT:

Kind of input	Indication range ** % of range	Basic error
Effective voltage, 400 V range	4 V...99 999 MV	0.2 %
Effective voltage, 100 V range	1 V...99 999 MV	0.2 %
Effective current, 1A range	0.01 A...99 999 MA	0.2 %
Effective current, 5A range	0.05 A...99 999 MA	0.2 %
Frequency	20...500 Hz	0.1 %
Active power*	-99 999...99 999 GW	0.5 %
Reactive power*	-99 999...99 999 Gvar	0.5 %
Apparent power*	0...99 999 GVA	0.5 %
Symmetrical 3-phase active power*	-99 999...99 999 GW	0.5 %
Symmetrical 3-phase reactive power*	-99 999...99 999 Gvar	0.5 %
Symmetrical 3-phase apparent power*	0...99 999 GVA	0.5 %
Active power factor*	-1...1	1 %
Reactive to active power factor ratio*	-100...100	1 %
Phase shift angle*	0...359.9 0	1 %
Active energy*	-99 999...99 999 GWh	0.5 %
Reactive energy*	-99 999...99 999 Gvarh	0.5 %
Apparent energy*	0...99 999 GVAh	0.5 %
Symmetrical 3-phase active energy*	-99 999...99 999 GWh	0.5 %
Symmetrical 3-phase reactive energy*	-99 999...99 999 Gvarh	0.5 %
Symmetrical 3-phase apparent energy*	0...99 999 GVA	0.5 %

\* The transducer preserves its class over 10% of the current and voltage range.

\*\* Ratio has been taken into consideration in the indication ranges.

### OUTPUTS:

● **Analogue outputs**, galvanically isolated with a resolution 0.025% of the range:

current programmable	0/4... 20 mA	load resistance $\leq 500 \Omega$
current programmable	0...5 mA	load resistance $\leq 2000 \Omega$
voltage programmable	0...10 V	load resistance $\geq 500 \Omega$

● **Relay outputs:**

- 2 relays, voltageless make contacts - maximal load:
  - voltage load 250 V a.c., 150 V d.c.,
  - current load 5 A, 30 V d.c., 250 V a.c.,
  - resistance load 1250 VA, 150 W.
- programmable alarm thresholds,
- three types of alarms,
- hysteresis defined by means of the lower and higher alarm threshold,
- signalling of the alarm operation on the LCD display.

● **Digital outputs:**

- interface RS-485,
- transmission protocol MODBUS
- ASCII 8N1, 7E1, 7O1,
- RTU 8N2, 8E1, 8O1, 8N1,
- baud rate 2400, 4800, 9600 bit/s
- maximal response time to the query frame 650 ms

● **Communication parameters of the programmer sockets:**

- interface RS-232
- data bits 8
- even parity lack
- stop bit 1
- rate 9600 bit/s
- flow control lack

● **Storage parameter:**

- transducer memory 750 samples (for the time recording mode)
- 375 samples (for other modes)
- minimal recording interval 1 s

● **Additional error from ambient temperature changes**

± (0.1 % of the range/10 K)






● **Conversion time**

min 600 ms (sampling time  
min 500 ms + output response  
time 100 ms)

● **Rated operating conditions:**

- supply voltage depending on the option code 85...230...253 V a.c./d.c
- 20...24...50 V a.c./d.c
- supply voltage frequency, a.c. 40...50...440 Hz
- ambient temperature -20...23...+55°C
- storage temperature -25...+85°C
- air relative humidity < 95% (no condensation)
- preheating time of the transducer 10 min.
- working position any

- **Long-term overload** 20%
- **Short-term overload (1 s)**
  - voltage input 2 Un (<1000 V)
  - current input 10 In
- **Display field** (in P12P-2) LCD 2 x 8 display  
indication range:- 99999...99999
- **Service** (in P12P-2) four keys:
 





  
- **Ensured protection degree through the case** IP 40 
- **Dimensions** 45 x 100 x 120 mm
- **Mass** < 0.3 kg
- **Fixing** on a 35 mm DIN rail
- **Power consumption** < 5 VA
- **Supply decay immunity** acc. EN 50082-2  
storage of all watt-hour meters states  
storage of all programming parameters  
storage of all minimal and maximal values
  
- **Electromagnetic compatibility:**
  - immunity acc. EN 50082-2
  - emission acc. EN 50081-2
- **Security requirements acc. IEC 61010-1 standard:**
  - installation category III
  - pollution level 2
  - phase-to-earth maximal working voltage:
    - input 600 V a.c.
    - supply 300 V a.c.
    - realys 300 V a.c.
    - analog output 50 V a.c.
    - RS-485 50 V a.c.

## 8. BEFORE A DAMAGE WILL BE SUBMITTED



In case of incorrect symptoms, please to acquaint with the below table.

SYMPTOMS	PROCEDURE
1. The transducer diode does not light. Lack of any indication.	Check the connection of the mains cable.
2. The time (e.g. <b>12:34:43</b> ) and other inscriptions are alternately displayed with the „ <b>P12P</b> “ inscription on the display.	The number of measurement <b>Cnt=0</b> has been introduced. The transducer is working in the <b>SLEEP</b> mode.
3. Inscriptions <b>Over.Hi</b> or <b>Over.Lo</b> are displayed on the display.	Check the correctness of the input signal connection. See the service manual. Check also the setting of <b>D_P</b> , <b>Char.In.</b> , <b>Trans U</b> and <b>Trans I</b> parameters.
4. A signal inconsistent with our expectations occurs on the transducer output.	One must check whether the load resistance of the analog output is compatible with the technical data. Check whether the individual characteristic is not switched on. In case of necessity make the change of the individual characteristic parameters or introduce factory parameters: <b>Par.fact.</b>
5. Lack of possibility to enter into the programming mode. The inscription <b>Security Error</b> is displayed.	The programming mode is secured by the password. In case when the user will forgot which password had been introduced, he should phone the nearest service workshop.
6. Lack of certainty if all character fields of the display are efficient.	Enter into the programming matrix and switched the display test on. The character fields are successively lighted in the first line till the lighting of the last field. Then the whole line is lighted. This operation is repeated for the second line. If otherwise, submit the fault to the nearest service workshop.

<p>7. During the moving along the programming mode, there occur values on the display, not conforming to the range of changes given in the table 1.</p>	<p>Check whether the individual characteristic is not switched on. In case of needs, enter into the programming matrix and accept the <b>Par. fact.</b> parameter. The converter will introduce values acc. to table 2.</p>
<p>8. A result inconsistent with our expectations appears on the display.</p>	<p>Check whether the individual characteristic is not switched on. Check also if the introduced value of the voltage and current ratio is correct (<b>Trans U</b> and <b>Trans I</b> parameters). In case of needs, enter into the programming matrix and accept the <b>Par. fact.</b> parameter. The transducer will introduce parameters acc. The table 2.</p>
<p>9. Symbols of <b>X1 In</b>, <b>X2 In</b>, <b>Y1 LCD</b> and <b>Y2 LCD</b> parameters are not displayed in the programming mode.</p>	<p>In case of switched individual characteristic off, the mentioned symbols are avoided.</p>
<p>10. Despite the alarm threshold overrunning, the alarm does not switch on and lack of signalling on the display.</p>	<p>Check the introduced into transducer delay of the alarm operation. If possible correct <b>Delay AI1</b>, <b>Delay AI2</b> parameters.</p>
<p>11. Despite the relay switching off, the alarm occurrence is still signalled on the display. Despite the alarm signalling on the display is over, the relay is still switched on.</p>	<p>Check whether the support of the alarm signalling or the relay is switched on. <b>Hold AI1</b>, <b>Hold AI2</b> parameters. In case of necessity switched it off.</p>
<p>12. Lack of possibility to erase the signalling from the display or switch the relay off by means of combination of keys when the parameter of the alarm signalling support is switched on.</p>	<p>The alarm is still operating. The erased alarm signalling from the display is immediately displayed again. The erased relay is switched on again, at once.</p>

<p><b>13.</b> Despite the alarm lasts, the erased alarm signalling from the display is not displayed again or/and the relay remains switched off.</p>	<p>Check whether a delay of alarm operation was not introduced. <b>Delay AI1, Delay AI2</b> parameters.</p>
<p><b>14.</b> Instead of displaying the measuring result, the transducer displays the parameter symbol and its value.</p>	<p>The transducer works in the review mode or the programming matrix. Press the erase key.</p>
<p><b>15.</b> A delay of the alarm operation was introduced e.g. 30 s, but the alarm after this time did not operate.</p>	<p>The persisting alarm state was shorter than the programmed one, i.e. a state of the alarm retract occurred during the alarm operation. In that case, the transducer begins to deduct the time from the beginning.</p>
<p><b>16.</b> The transducer does not communicate with the computer through the RS-485 interface.</p>	<p>Check if the interface conductors were correctly connected (<b>A, B, GDN</b>). Then, check the setting of the interface in the programming matrix (<b>Mode, Baud, Address</b>). These parameters must be the same as in the used software.</p>
<p><b>17.</b> The transducer does not communicate with the computer through the PD14 programmer.</p>	<p>Check whether the PD14 programmer was correctly connected. Check if in the used software the proper communication port was chosen. The programmer works only with one transducer socket.</p>

## 9. EXAMPLES OF P12P TRANSDUCER PROGRAMMINGS

### Example 1 - Programming of the individual characteristic of the display

We want to program in order to the 0.00 value on the display will correspond to the 20 Hz value, whereas the 100.00 value will correspond to the 100 Hz value. One must:

- enter into the programming mode and choose the **D\_P** parameter responsible for the decimal point. Set the decimal point on **000.00**
- choose the **Char. In.** parameter and switched the individual characteristic **On**
- choose the **X1 IN** parameter and introduce the value 20
- transit on the **Y1 LCD** parameter and introduce the value 0
- transit on the **X2 IN** parameter and introduce the value 100
- transit on the **Y2 LCD** parameter and introduce the value 100

### Example 2 - Programming of the inverse individual characteristic

If we want to program in order to the 100.00 value on the display will correspond to the 0 V value, whereas the 20.00 value will correspond to the 100 V value. One must:

- enter into the programming mode and choose the **D\_P** parameter responsible for the decimal point. Set the decimal point on **000.00**
- choose the **Char. In.** parameter and switched the individual characteristic **On**
- choose the **X1 IN** parameter and introduce the value 0
- transit on the **Y1 LCD** parameter and introduce the value 100
- transit on the **X2 IN** parameter and introduce the value 100
- transit on the **Y2 LCD** parameter and introduce the value 20

### Example 3 - Alarm programming with hysteresis

If we want to program the alarm 1 in order to at the 1500 W value the alarm was switched on, whereas it was switched off at the 30 W and the alarm 2 operation in order to at the 0 var value it was switched off and switched on at the 320 var value. One must:

- enter into the programming mode and choose the **Input AI1** parameter and introduce **P**
- transit on **Low AI1** parameter and introduce the 1500 value
- transit on **High AI1** parameter and introduce the 30 value
- transit on the **Type AI1** parameter and choose the function marked as **Normal**
- choose the **Input AI2** parameter and introduce **Q**
- transit on the **Low AI2** parameter and introduce the value 0
- transit on the **High AI2** parameter and introduce the value 320
- transit on the **Type AI2** parameter and choose the **Normal** function

#### **Example 4** - Alarm programming in the set interval with delay

If we want that the alarm 1 was switched on in the interval from 1000 VA to 3000 VA and operated only after 10 seconds, one must:

- enter into the programming mode and choose the **Input AI1** parameter and introduce **S**
- transit on **Low AI1** parameter and introduce the 1000 value
- transit on **High AI1** parameter and introduce the 3000 value
- transit on the **Type AI1** parameter and choose the **On** function
- transit on the **Delay AI1** parameter and introduce the value 10.0

In case of continuation of the alarm state for more than 10.0 seconds, the transducer will switch the alarm relay on or/and indicate this on the display.

#### **Example 5** - Programming of the analog output

If we want to program in order to the 4.00 mA value on the analog output will correspond to the 50 Hz value on the display, whereas the 20.00 mA value will correspond to the 100 Hz value. One must:

- enter into the programming mode and choose the **InputOut** parameter and introduce **frequen**
- transit on **Char. Out** parameter and switched on the **On** individual characteristic
- choose the **X1 LCD** parameter and introduce the 50 value
- transit on **Y1 Out** parameter and introduce the 4.00 value
- transit on the **X2 LCD** parameter and introduce 100 value
- transit on the **Y2 Out** parameter and introduce the value 20.00

#### **Example 6** - Programming of the transducer cooperating with measuring transformers

If the transducer is to work with an external current 1500 A/5 A and voltage 6000 V/100 V transformers, one must:

- enter into the programming mode and choose the **Trans U** parameter and introduce **60**
- transit on the **Trans I** parameter and introduce 300 value

## 10. OPTIONS CODES AND ORDERING

Table 5.

Transducer of single-phase network parameters P12P	X	X	XX	X	X	X	XX	X
<b>Kind of transducer:</b>								
without a display*		1						
with a display		2						
<b>Input range:</b>								
100 V, 1 A			1					
100 V, 5 A			2					
400 V, 1 A			3					
400 V, 5 A			4					
on order **			X					
<b>Programmed converted parameter *</b>								
voltage			00					
current			01					
frequency			02					
active power			03					
reactive power			04					
apparent power			05					
3-phase active power			06					
3-phase reactive power			07					
3-phase apparent power			08					
cosφ			09					
tgφ			10					
φ			11					
active energy			12					
reactive energy			13					
apparent energy			14					
3-phase active energy			15					
3-phase reactive energy			16					
3-phase apparent energy			17					
on order **			XX					
<b>Output signals:</b>								
voltage 0...10V			1					
current 0...20mA			2					
current 4...20mA			3					
current 0...5mA			4					
on order **			X					
<b>Supply:</b>								
85..253 V a.c./d.c.						1		
20..50 V a.c./d.c.						2		
<b>Kind of terminals:</b>								
socket - screw plug							0	
on order ***							X	
<b>Options:</b>								
standard								00
custom-made **								XX
<b>Acceptance tests:</b>								
without a quality inspection certificate								8
with an extra quality inspection certificate								7
acc. user's requirements **								X

- \* The modification of the converted parameter is possible from the keyboard (P12P-2) through PD14 or RS-485. When ordering, one must give the code of converted parameter which is to be programmed.
- \*\* The option must be agreed with the producer
- \*\*\* Available option with self-locking terminals

**The transducer maintains its class to the fourfold decrease of the basic range of the input signal. In the P12S-1 transducer, besides the basic range, one must give the required sub-range in remarks. In case when the given sub-range is smaller than the basic range divided by four, one must precise the input signal on the order as XX.**

### Coding examples

#### **1. Transducer with a basic range**

**P12P- 2 - 1 - 03 - 3 - 1 - 0 - 00 - 8 means:**

- 2 - execution of a P12P transducer with a display
- 1 - input range: 100 V, 1 A
- 03 - programmed by the manufacturer to convert active power
- 3 - current output signal: 4...20 mA
- 1 - supply voltage: 85...253 V a.c./d.c.
- 0 - socket - screw-plug terminals
- 00 - standard execution
- 8 - without an extra quality inspection certificate.

#### **2. Transducer with a measuring sub-range**

**P12P-1- 2 - 00 - 2 - 1 - 0 - 00 - 8 sub-range 0...50 V code means:**

- 1 - execution of a P12P transducer without a display
- 2 - input range: 100 V, 5 A
- 00 - programmed by the manufacturer to convert the 0...50 V range
- 2 - current output signal: 0...20 mA
- 1 - supply voltage: 85...253 V a.c./d.c.
- 0 - socket - screw-plug terminals
- 00 - standard execution
- 8 - without an extra quality inspection certificate.

## 11. MAINTENANCE AND GUARANTEE

The P12P transducer does not require any periodical maintenance.  
In case of some incorrect operations:

### 1. Within the period given in the guarantee card and from the date of purchase

One should take the transducer down from the installation and return it to the manufacturer's Quality Control Department.

If the unit has been used in compliance with the instructions, the manufacturer guarantees to repair it free of charges.

The disassembling of the housing can cause the cancellation of the granted guarantee.

### 2. After the guarantee period

One should return the transducer to repair in an authorized service shop.  
Spare parts are available for a period of ten years from the date of purchase.

Our policy is one of continuous improvement and we reserve the right to make changes in design and specification of any products as engineering advances or necessity requires and revise the above specification without notice.



## SALES PROGRAM

- DIGITAL and BARGRAPH PANEL METERS
- MEASURING TRANSDUCERS
- ANALOG PANEL METERS (DIN INSTRUMENTS)
- DIGITAL CLAMP-ON METERS
- INDUSTRIAL PROCESS and POWER CONTROLLERS
- CHART and PAPERLESS RECORDERS
- POWER CONTROL UNITS AND SOLIDE-STATE RELAYS
- 1-PHASE and 3-PHASE WATT-HOUR METERS
- ELEMENTS OF INTEGRATION SYSTEMS
- ACCESSORIES for MEASURING INSTRUMENTS (SHUNTS)
- MEASURING SYSTEMS (ENERGY, HEAT, CONTROL)
- CUSTOM – MADE PRODUCTS ACCORDING CUSTOMER'S REQUIREMENTS

**MEASUREMENT  
CONTROL  
RECORDING**

### **WE ALSO OFFER OUR SERVICES IN THE PRODUCTION OF:**

- ALUMINIUM ALLOY PRESSURE CASTINGS
- PRECISION ENGINEERING and THERMOPLASTICS PARTS
- SUBCONTRACTING of ELECTRONIC DEVICES (SMT)
- PREASSURE CASTINGS and OTHER TOOLS

### **QUALITY PROCEDURES:**

According to ISO 9001 and ISO 14001 international requirements.  
All our instruments have CE mark.  
For more information, please write to or phone our Export Department.



**Lubuskie Zakłady Aparatów Elektrycznych - LUMEL S.A.**

ul. Sulechowska 1, 65-022 Zielona Góra, Poland

Tel.: (48-68) 32 95 100 (exchange)

Fax: (48-68) 32 95 101

[www.lumel.com.pl](http://www.lumel.com.pl)

e-mail: [lumel@lumel.com.pl](mailto:lumel@lumel.com.pl)

### **Export Department:**

Tel.: (48-68) 329 53 02 or 53 04

Fax: (48-68) 325 40 91

e-mail: [export@lumel.com.pl](mailto:export@lumel.com.pl)