



new

Includes
R.SAFE
RFID Safety Switches

SR
Safety Interfaces

Safety Devices and Solutions for the Machine Automation Industry

Panorama

COMPANY PROFILE

YOUR TECHNOLOGY PARTNER SINCE 1959

ReeR was established in 1959 with a mission to distribute automation products for industrial, lighting, and home applications. By the mid-1970s, the first safety sensors were developed. Not long after, the first light curtains were produced.

Today, ReeR is the leading Italian company in the industry and one of the largest manufacturers in the world of optoelectronic sensors for industrial safety.

The Safety Division has the expertise to support customers all over the world. Its talented network of distributors provides industry-leading support services to customers in more than 50 countries.

QUALITY

ReeR is committed to continuously improving its quality management system by minimizing defective returns and ensuring high product reliability.

Product traceability and production process control are delivered using ReeR's proprietary management software.

Product quality is guaranteed by the TÜV certified Quality System according to the ISO 9001 standard.

SAFETY AND AUTOMATION

Safety is essential in every workplace. It becomes even more crucial in highly automated environments.

Thanks to our collaboration with world-leading companies in the machine-tool, automotive, packaging, and palletization industries, ReeR is able to offer a wide range of safety devices such as light curtains, programmable controllers, photocells, laser scanners, and interfaces able to meet the demands of any application.

ReeR specializes in the field of optoelectronic curtains for automation, measurement, and control.

REER'S INDUSTRY EXPERTISE

Technological excellence and application know-how embody the spirit of ReeR.

Fourteen percent (14%) of ReeR's workforce is employed in the R&D department with expertise in safety hardware, software, and firmware.

In addition to developing its own technology and devices, the experts at ReeR work hard to participate in the standardization development process for the industry. As one of the main players in the space, ReeR plays a vital role in national and international organizing committees on machinery safety requirements.



HQ in Turin, Italy



Logistic centre and warehouse in Leini, Italy



Electronic components assembly line in Turin, Italy



SAFETY LIGHT CURTAINS

EOS

SAFEGATE

ADMIRAL



EOS4 - EOS2

COMPACT SAFETY LIGHT CURTAINS AND GRIDS

One simple product range to cover most of today's industrial applications.

- Safety light curtains: finger, hand and body detection
- Safety light grids: multi-beam (2, 3 or 4 beams for access control)
- Unique features and a comprehensive range of accessories
- Standard versions with automatic restart
- Integrated function versions with selectable automatic/manual restart
- Operating range up to 20 m, protected height up to 2,2 m

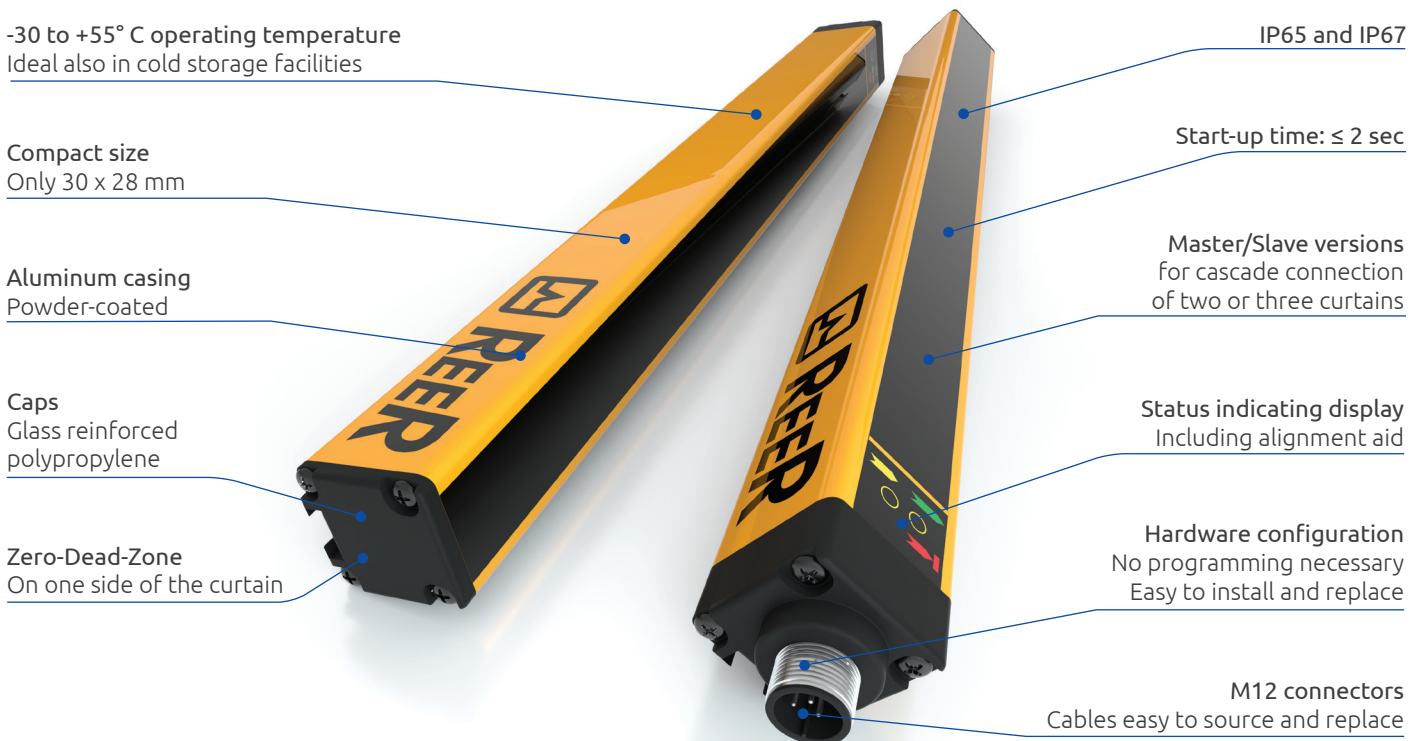

CHARACTERISTICS

STANDARD (A)		INTEGRATED FUNCTIONS (X)		INTEGRATED FUNCTIONS (X) FOR CASCADE CONNECTION
EOS4 A / AT / ATL EOS2 A / AT / ATL	EOS4 AH (high range)	EOS4 X / XT / XTL EOS2 X / XT / XTL	EOS4 XH (high range)	EOS4 XM / XS / XS2 EOS2 XM / XS / XS2
Selectable operating range: 0 ... 4 m - low, 0 ... 12 m - high	Selectable operating range: 0 ... 10 m - low 3 ... 20 m - high	Selectable operating range: 0 ... 4 m - low, 0 ... 12 m - high	Selectable operating range: 0 ... 10 m - low 3 ... 20 m - high	Selectable operating range: 0 ... 4 m - low, 0 ... 12 m - high
EOS4 A with 14 mm resolution models: 0 ... 3 m - low, 1 ... 6 m - high		EOS4 X with 14 mm resolution models: 0 ... 3 m - low, 1 ... 6 m - high		EOS4 with 14 mm resolution models: 0 ... 3 m - low, 1 ... 6 m - high
ATL versions: 0 ... 2 m - low, 0 ... 6 m - high		XTL versions: 0 ... 2 m - low, 0 ... 6 m - high		
Automatic Start/Restart		Selectable manual or automatic Start/Restart		
External relay monitoring (EDM) through external interfaces, i.e. SR ONE, Mosaic or safety PLC		Integrated feedback input for external relay monitoring (EDM). When a relay output is needed, the use of a SR ZERO is recommended		

2 safety static outputs PNP with auto-test protected against short circuits and overloads

CABLES NEEDED

EOS4 and EOS2 standard versions (A)	EOS4 and EOS2 with integrated functions versions (X)
Emitter: M12 5-pole (CDx)	Emitter: M12 5-pole (CDx)
Receiver: M12 5-pole (CDx)	Receiver: M12 8-pole (C8Dx)
Master, Slave 2 and Slave connection	M12 5-pole (CDx)



See page 42

EOS4 - EOS2 MASTER/SLAVE FOR CASCADE CONNECTION



Master/Slave versions for cascade connection of two or three curtains

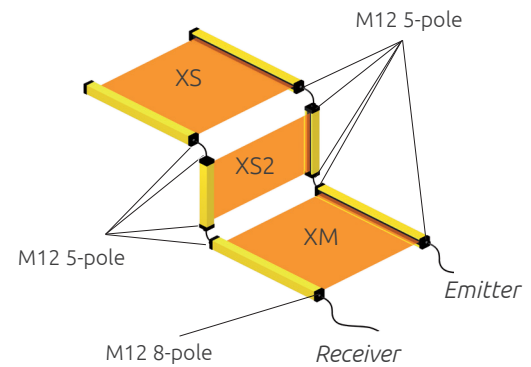

EOS4 - EOS2 WTF / WTHF

WITH WATERTIGHT ENCLOSURE, FOOD-GRADED, IP69K CERTIFIED



Available also with integrated heater

Special models with watertight enclosure allow light curtains and light grids to be used in harsh working environments, with exposure to water and steam. The use of inert and non-toxic components allows WTF and WTHF enclosures to be used in the Food & Beverage industry, where frequent washdown procedures are requested.



Material resistance test according to cleaning procedures for food and beverage industry.



The IP69K rated compact WTF/WTHF cylindrical enclosure (56 mm diameter) can withstand up to 80 bar of water jets pressure at the temperature of +80 °C. The enclosure incorporates a valve to drain humidity and to avoid condensation.

WTF: watertight
WTHF: watertight + integrated heater

EOS4 - EOS2 T VERSIONS RESISTANT TO HIGH VIBRATIONS

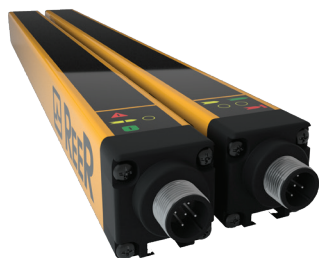

Special versions resistant to high vibrations for applications on presses and in the textile industry. Available as Standard version (AT), with Integrated Functions (XT) and with reduced sensibility for low range applications (ATL, XTL).

These versions are able to maintain beams alignment also in the presence of strong mechanical stresses and vibrations according to EN 60068-2-6:2009. The use of Vibration Dampers (SAV) is mandatory.

EOS4 ATEX

SAFETY LIGHT CURTAINS FOR EXPLOSIVE ATMOSPHERE



Ideal for access protection in environments with potentially explosive atmosphere.

- Typo 4, SIL 3, PL e safety light curtains
- Classified Zone 2, 22 ATEX (Directive 2014/34/UE)
- Gas: II 3G Ex nA IIC T6 Gc, Dust: II 3D Ex tc IIIC T 60 °C Dc

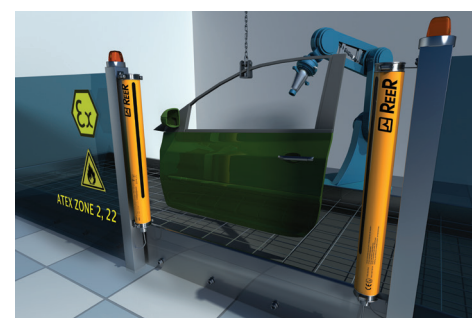

EOS4 - EOS2

PART NUMBERS

EOS4 - STANDARD VERSIONS (A) AND WITH INTEGRATED FUNCTIONS (X)



Resolution 14 mm

A versions	EOS4 151 A	-	EOS4 301 A	EOS4 451 A	EOS4 601 A	EOS4 751 A	EOS4 901 A	EOS4 1051 A	EOS4 1201 A	EOS4 1351 A	EOS4 1501 A	EOS4 1651 A	EOS4 1801 A	EOS4 1951 A
Part number	1310000	-	1310001	1310002	1310003	1310004	1310005	1310006	1310007	1310008	1310009	1310070	1310071	1310711
X versions	EOS4 151 X	-	EOS4 301 X	EOS4 451 X	EOS4 601 X	EOS4 751 X	EOS4 901 X	EOS4 1051 X	EOS4 1201 X	EOS4 1351 X	EOS4 1501 X	EOS4 1651 X	EOS4 1801 X	EOS4 1951 X
Part number	1310010	-	1310011	1310012	1310013	1310014	1310015	1310016	1310017	1310018	1310019	1310072	1310073	1310712
Protected height (mm)	160		310	460	610	760	910	1060	1210	1360	1510	1660	1810	1960
Number of beams	15		30	45	60	75	90	105	120	135	150	165	180	195
Overall height (mm)	213		363	513	663	813	963	1113	1263	1413	1563	1713	1863	2013



Resolution 20 mm

AH versions	EOS4 152 AH	-	EOS4 302 AH	EOS4 452 AH	EOS4 602 AH	EOS4 752 AH	EOS4 902 AH	EOS4 1052 AH	EOS4 1202 AH	EOS4 1352 AH	EOS4 1502 AH	EOS4 1652 AH	EOS4 1802 AH	EOS4 1952 AH
Part number	1310150	-	1310151	1310152	1310153	1310154	1310155	1310156	1310157	1310158	1310159	1310180	1310181	1310715
XH versions	EOS4 152 XH	-	EOS4 302 XH	EOS4 452 XH	EOS4 602 XH	EOS4 752 XH	EOS4 902 XH	EOS4 1052 XH	EOS4 1202 XH	EOS4 1352 XH	EOS4 1502 XH	EOS4 1652 XH	EOS4 1802 XH	EOS4 1952 XH
Part number	1310160	-	1310161	1310162	1310163	1310164	1310165	1310166	1310167	1310168	1310169	1310182	1310183	1310716
Protected height (mm)	160		310	460	610	760	910	1060	1210	1360	1510	1660	1810	1960
Number of beams	15		30	45	60	75	90	105	120	135	150	165	180	195
Overall height (mm)	213		363	513	663	813	963	1113	1263	1413	1563	1713	1863	2013



Resolution 30 mm

A versions	EOS4 153 A	EOS4 253 A	EOS4 303 A	EOS4 453 A	EOS4 603 A	EOS4 753 A	EOS4 903 A	EOS4 1053 A	EOS4 1203 A	EOS4 1353 A	EOS4 1503 A	EOS4 1653 A	EOS4 1803 A	EOS4 1953 A	EOS4 2103 A	EOS4 2253 A
Part number	1310200	1311205	1310201	1310202	1310203	1310204	1310205	1310206	1310207	1310208	1310209	1310270	1310271	1310719	1310720	1310721
X versions	EOS4 153 X	EOS4 253 X	EOS4 303 X	EOS4 453 X	EOS4 603 X	EOS4 753 X	EOS4 903 X	EOS4 1053 X	EOS4 1203 X	EOS4 1353 X	EOS4 1503 X	EOS4 1653 X	EOS4 1803 X	EOS4 1953 X	EOS4 2103 X	EOS4 2253 X
Part number	1310210	1311200	1310211	1310212	1310213	1310214	1310215	1310216	1310217	1310218	1310219	1310272	1310273	1310733	1310734	1310735
AH versions	EOS4 153 AH	-	EOS4 303 AH	EOS4 453 AH	EOS4 603 AH	EOS4 753 AH	EOS4 903 AH	EOS4 1053 AH	EOS4 1203 AH	EOS4 1353 AH	EOS4 1503 AH	EOS4 1653 AH	EOS4 1803 AH	EOS4 1953 AH	EOS4 2103 AH	EOS4 2253 AH
Part number	1310250	-	1310251	1310252	1310253	1310254	1310255	1310256	1310257	1310258	1310259	1310280	1310281	1310736	1310737	1310738
XH versions	EOS4 153 XH	-	EOS4 303 XH	EOS4 453 XH	EOS4 603 XH	EOS4 753 XH	EOS4 903 XH	EOS4 1053 XH	EOS4 1203 XH	EOS4 1353 XH	EOS4 1503 XH	EOS4 1653 XH	EOS4 1803 XH	EOS4 1953 XH	EOS4 2103 XH	EOS4 2253 XH
Part number	1310260	-	1310261	1310262	1310263	1310264	1310265	1310266	1310267	1310268	1310269	1310282	1310283	1310739	1310740	1310741
Protected height (mm)	160	260	310	460	610	760	910	1060	1210	1360	1510	1660	1810	1960	2110	2260
Number of beams	8	13	16	23	31	38	46	53	61	68	76	83	91	98	106	113
Overall height (mm)	213	313	363	513	663	813	963	1113	1263	1413	1563	1713	1863	2013	2163	2313



Resolution 40 mm

A versions	EOS4 154 A	EOS4 254 A	EOS4 304 A	EOS4 454 A	EOS4 604 A	EOS4 754 A	EOS4 904 A	EOS4 1054 A	EOS4 1204 A	EOS4 1354 A	EOS4 1504 A	EOS4 1654 A	EOS4 1804 A	EOS4 1954 A	EOS4 2104 A	EOS4 2254 A
Part number	1310300	1311202	1310301	1310302	1310303	1310304	1310305	1310306	1310307	1310308	1310309	1310370	1310371	1310723	1310724	1310725
X versions	EOS4 154 X	EOS4 254 X	EOS4 304 X	EOS4 454 X	EOS4 604 X	EOS4 754 X	EOS4 904 X	EOS4 1054 X	EOS4 1204 X	EOS4 1354 X	EOS4 1504 X	EOS4 1654 X	EOS4 1804 X	EOS4 1954 X	EOS4 2104 X	EOS4 2254 X
Part number	1310310	1311209	1310311	1310312	1310313	1310314	1310315	1310316	1310317	1310318	1310319	1310372	1310373	1310751	1310752	1310753
AH versions	EOS4 154 AH	-	EOS4 304 AH	EOS4 454 AH	EOS4 604 AH	EOS4 754 AH	EOS4 904 AH	EOS4 1054 AH	EOS4 1204 AH	EOS4 1354 AH	EOS4 1504 AH	EOS4 1654 AH	EOS4 1804 AH	EOS4 1954 AH	EOS4 2104 AH	EOS4 2254 AH
Part number	1310350	-	1310351	1310352	1310353	1310354	1310355	1310356	1310357	1310358	1310359	1310380	1310381	1310754	1310755	1310756
XH versions	EOS4 154 XH	-	EOS4 304 XH	EOS4 454 XH	EOS4 604 XH	EOS4 754 XH	EOS4 904 XH	EOS4 1054 XH	EOS4 1204 XH	EOS4 1354 XH	EOS4 1504 XH	EOS4 1654 XH	EOS4 1804 XH	EOS4 1954 XH	EOS4 2104 XH	EOS4 2254 XH
Part number	1310360	-	1310361	1310362	1310363	1310364	1310365	1310366	1310367	1310368	1310369	1310382	1310383	1310757	1310758	1310759
Protected height (mm)	160	260	310	460	610	760	910	1060	1210	1360	1510	1660	1810	1960	2110	2260
Number of beams	6	9	11	16	21	26	31	36	41	46	51	56	61	66	71	76
Overall height (mm)	213	313	363	513	663	813	963	1113	1263	1413	1563	1713	1863	2013	2163	2313



Resolution 50 mm

A versions	EOS4 155 A	EOS4 305 A	EOS4 455 A	EOS4 605 A	EOS4 755 A	EOS4 905 A	EOS4 1055 A	EOS4 1205 A	EOS4 1355 A	EOS4 1505 A	EOS4 1655 A	EOS4 1805 A	EOS4 1955 A	EOS4 2105 A	EOS4 2255 A
Part number	1310400	1310401	1310402	1310403	1310404	1310405	1310406	1310407	1310408	1310409	1310470	1310471	1310769	1310770	1310761
X versions	EOS4 155 X	EOS4 305 X	EOS4 455 X	EOS4 605 X	EOS4 755 X	EOS4 905 X	EOS4 1055 X	EOS4 1205 X	EOS4 1355 X	EOS4 1505 X	EOS4 1655 X	EOS4 1805 X	EOS4 1955 X	EOS4 2105 X	EOS4 2255 X
Part number	1310410	1310411	1310412	1310413	1310414	1310415	1310416	1310417	1310418	1310419	1310472	1310473	1310772	1310773	1310774
AH versions	EOS4 155 AH	EOS4 305 AH	EOS4 455 AH	EOS4 605 AH	EOS4 755 AH	EOS4 905 AH	EOS4 1055 AH	EOS4 1205 AH	EOS4 1355 AH	EOS4 1505 AH	EOS4 1655 AH	EOS4 1805 AH	EOS4 1955 AH	EOS4 2105 AH	EOS4 2255 AH
Part number	1310450	1310451	1310452	1310453	1310454	1310455	1310456	1310457	1310458	1310459	1310480	1310481	1310775	1310776	1310777
XH versions	EOS4 155 XH	EOS4 305 XH	EOS4 455 XH	EOS4 605 XH	EOS4 755 XH	EOS4 905 XH	EOS4 1055 XH	EOS4 1205 XH	EOS4 1355 XH	EOS4 1505 XH	EOS4 1655 XH	EOS4 1805 XH	EOS4 1955 XH	EOS4 2105 XH	EOS4 2255 XH
Part number	1310460	1310461	1310462	1310463	1310464	1310465	1310466	1310467	1310468	1310469	1310482	1310483	1310778	1310779	1310780
Protected height (mm)	160	310	460	610	760	910	1060	1210	1360	1510	1660	1810	1960	2110	2260
Number of beams	4	8	12	16	20	24	28	32	36	40	44	48	52	54	60
Overall height (mm)	213	363	513	663	813	963	1113	1263	1413	1563	1713	1863	2013	2163	2313



Resolution 90 mm

A versions	-	EOS4 309 A	EOS4 459 A	EOS4 609 A	EOS4 759 A	EOS4 909 A	EOS4 1059 A	EOS4 1209 A	EOS4 1359 A	EOS4 1509 A	EOS4 1659 A	EOS4 1809 A	EOS4 1959 A	EOS4 2109 A	EOS4 2259 A
Part number	-	1310501	1310502	1310503	1310504	1310505	1310506	1310507	1310508	1310509	1310570	1310571	1310790	1310791	1310792
X versions	-	EOS4 309 X	EOS4 459 X	EOS4 609 X	EOS4 759 X	EOS4 909 X	EOS4 1059 X	EOS4 1209 X	EOS4 1359 X	EOS4 1509 X	EOS4 1659 X	EOS4 1809 X	EOS4 1959 X	EOS4 2109 X	EOS4 2259 X
Part number	-	1310511	1310512	1310513	1310514	1310515	1310516	1310517	1310518	1310519	1310572	1310573	1310793	1310707	1310794
AH versions	-	EOS4 309 AH	EOS4 459 AH	EOS4 609 AH	EOS4 759 AH	EOS4 909 AH	EOS4 1059 AH	EOS4 1209 AH	EOS4 1359 AH	EOS4 1509 AH	EOS4 1659 AH	EOS4 1809 AH	EOS4 1959 AH	EOS4 2109 AH	EOS4 2259 AH
Part number	-	1310551	1310552	1310553	1310554	1310555	1310556	1310557	1310558	1310559	1310580	1310581	1310795	1310796	1310797
XH versions	-	EOS4 309 XH	EOS4 459 XH	EOS4 609 XH	EOS4 759 XH	EOS4 909 XH	EOS4 1059 XH	EOS4 1209 XH	EOS4 1359 XH	EOS4 1509 XH	EOS4 1659 XH	EOS4 1809 XH	EOS4 1959 XH	EOS4 2109 XH	EOS4 2259 XH
Part number	-	1310561	1310562	1310563	1310564	1310565	1310566	1310567	1310568	1310569	1310582	1310583	1310798	1310799	1310800
Protected height (mm)	-	310	460	610	760	910	1060	1210	1360	1510	1660	1810	1960	2110	2260
Number of beams	-	4	6	8	10	12	14	16	18	20	22	24	26	28	30
Overall height (mm)	-	363	513	663	813	963	1113	1263	1413	1563	1713	1863	2013	2163	2313

EOS2 - STANDARD VERSIONS (A) AND WITH INTEGRATED FUNCTIONS (X)



Resolution 30 mm

A versions	EOS2 153 A	EOS2 253 A	EOS2 303 A	EOS2 453 A	EOS2 603 A	EOS2 753 A	EOS2 903 A	EOS2 1053 A	EOS2 1203 A	EOS2 1353 A	EOS2 1503 A	EOS2 1653 A	EOS2 1803 A	EOS2 1953 A	EOS2 2103 A	EOS2 2253 A
Part number	1320200	1321205	1320201	1320202	1320203	1320204	1320205	1320206	1320207	1320208	1320209	1320270	1320271	1320719	1320720	1320721
X versions	EOS2 153 X	EOS2 253 X	EOS2 303 X	EOS2 453 X	EOS2 603 X	EOS2 753 X	EOS2 903 X	EOS2 1053 X	EOS2 1203 X	EOS2 1353 X	EOS2 1503 X	EOS2 1653 X	EOS2 1803 X	EOS2 1953 X	EOS2 2103 X	EOS2 2253 X
Part number	1320210	1321200	1320211	1320212	1320213	1320214	1320215	1320216	1320217	1320218	1320219	1320272	1320273	1320733	1320734	1320735
Protected height (mm)	160	260	310	460	610	760	910	1060	1210	1360	1510	1660	1810	1960	2110	2260
Number of beams	8	13	16	23	31	38	46	53	61	68	76	83	91	98	106	113
Overall height (mm)	213	313	363	513	663	813	963	1113	1263	1413	1563	1713	1863	2013	2163	2313



Resolution 40 mm

A versions	EOS2 154 A	EOS2 254 A	EOS2 304 A	EOS2 454 A	EOS2 604 A	EOS2 754 A	EOS2 904 A	EOS2 1054 A	EOS2 1204 A	EOS2 1354 A	EOS2 1504 A	EOS2 1654 A	EOS2 1804 A	EOS2 1954 A	EOS2 2104 A	EOS2 2254 A
Part number	1320300	1321202	1320301	1320302	1320303	1320304	1320305	1320306	1320307	1320308	1320309	1320370	1320371	1320723	1320724	1320725
X versions	EOS2 154 X	EOS2 254 X	EOS2 304 X	EOS2 454 X	EOS2 604 X	EOS2 754 X	EOS2 904 X	EOS2 1054 X	EOS2 1204 X	EOS2 1354 X	EOS2 1504 X	EOS2 1654 X	EOS2 1804 X	EOS2 1954 X	EOS2 2104 X	EOS2 2254 X
Part number	1320310	1321209	1320311	1320312	1320313	1320314	1320315	1320316	1320317	1320318	1320319	1320372	1320373	1320751	1320752	1320753
Protected height (mm)	160	260	310	460	610	760	910	1060	1210	1360	1510	1660	1810	1960	2110	2260
Number of beams	6	9	11	16	21	26	31	36	41	46	51	56	61	66	71	76
Overall height (mm)	213	313	363	513	663	813	963	1113	1263	1413	1563	1713	1863	2013	2163	2313

EOS4 - EOS2

PART NUMBERS



Resolution 50 mm

A versions	EOS2 155 A	EOS2 305 A	EOS2 455 A	EOS2 605 A	EOS2 755 A	EOS2 905 A	EOS2 1055 A	EOS2 1205 A	EOS2 1355 A	EOS2 1505 A	EOS2 1655 A	EOS2 1805 A	EOS2 1955 A	EOS2 2105 A	EOS2 2255 A
Part number	1320400	1320401	1320402	1320403	1320404	1320405	1320406	1320407	1320408	1320409	1320470	1320471	1320769	1320770	1320771
X versions	EOS2 155 X	EOS2 305 X	EOS2 455 X	EOS2 605 X	EOS2 755 X	EOS2 905 X	EOS2 1055 X	EOS2 1205 X	EOS2 1355 X	EOS2 1505 X	EOS2 1655 X	EOS2 1805 X	EOS2 1955 X	EOS2 2105 X	EOS2 2255 X
Part number	1320410	1320411	1320412	1320413	1320414	1320415	1320416	1320417	1320418	1320419	1320472	1320473	1320772	1320773	1320774
Protected height (mm)	160	310	460	610	760	910	1060	1210	1360	1510	1660	1810	1960	2110	2260
Number of beams	4	8	12	16	20	24	28	32	36	40	44	48	52	54	60
Overall height (mm)	213	363	513	663	813	963	1113	1263	1413	1563	1713	1863	2013	2163	2313



Resolution 90 mm

A versions	-	EOS2 309 A	EOS2 459 A	EOS2 609 A	EOS2 759 A	EOS2 909 A	EOS2 1059 A	EOS2 1209 A	EOS2 1359 A	EOS2 1509 A	EOS2 1659 A	EOS2 1809 A	EOS2 1959 A	EOS2 2109 A	EOS2 2259 A
Part number	-	1320501	1320502	1320503	1320504	1320505	1320506	1320507	1320508	1320509	1320570	1320571	1320790	1320791	1320792
X versions	-	EOS2 309 X	EOS2 459 X	EOS2 609 X	EOS2 759 X	EOS2 909 X	EOS2 1059 X	EOS2 1209 X	EOS2 1359 X	EOS2 1509 X	EOS2 1659 X	EOS2 1809 X	EOS2 1959 X	EOS2 2109 X	EOS2 2259 X
Part number	-	1320511	1320512	1320513	1320514	1320515	1320516	1320517	1320518	1320519	1320572	1320573	1320793	1320794	1320794
Protected height (mm)		310	460	610	760	910	1060	1210	1360	1510	1660	1810	1960	2110	2260
Number of beams		4	6	8	10	12	14	16	18	20	22	24	26	28	30
Overall height (mm)		363	513	663	813	963	1113	1263	1413	1563	1713	1863	2013	2163	2313

EOS4 - MULTIBEAMS



2, 3, 4 beams

A versions	EOS4 2B A	EOS4 3B A	EOS4 4B A
Part number	1310600	1310601	1310602
X versions	EOS4 2B X	EOS4 3B X	EOS4 4B X
Part number	1310610	1310611	1310612
AH versions	EOS4 2B AH	EOS4 3B AH	EOS4 4B AH
Part number	1310650	1310651	1310652
XH versions	EOS4 2B XH	EOS4 3B XH	EOS4 4B XH
Part number	1310660	1310661	1310662
Number of beams	2	3	4
Beam spacing (mm)	500	400	300
Protected height (mm)	510	810	910
Overall height (mm)	653	953	1053

EOS2 - MULTIBEAMS



2, 3, 4 beams

A versions	EOS2 2B A	EOS2 3B A	EOS2 4B A
Part number	1320600	1320601	1320602
X versions	EOS2 2B X	EOS2 3B X	EOS2 4B X
Part number	1320610	1320611	1320612
Number of beams	2	3	4
Beam spacing (mm)	500	400	300
Protected height (mm)	510	810	910
Overall height (mm)	653	953	1053

EOS4 - MASTER/SLAVE VERSIONS WITH INTEGRATED FUNCTIONS



Resolution 14 mm

MASTER	-	-	EOS4 301 XM	EOS4 451 XM	EOS4 601 XM	EOS4 751 XM	EOS4 901 XM	EOS4 1051 XM	EOS4 1201 XM	EOS4 1351 XM	EOS4 1501 XM	EOS4 1651 XM	EOS4 1801 XM	EOS4 1951 XM
Part number	-	-	1310021	1310022	1310023	1310024	1310025	1310026	1310027	1310028	1310029	1310074	1310075	1310713
SLAVE	EOS4 151 XS	-	EOS4 301 XS	EOS4 451 XS	EOS4 601 XS	EOS4 751 XS	EOS4 901 XS	EOS4 1051 XS	EOS4 1201 XS	EOS4 1351 XS	EOS4 1501 XS	EOS4 1651 XS	EOS4 1801 XS	EOS4 1951 XS
Part number	1310030	-	1310031	1310032	1310033	1310034	1310035	1310036	1310037	1310038	1310039	1310076	1310076	1310729
SLAVE 2	-	-	EOS4 301 XS2	EOS4 451 XS2	EOS4 601 XS2	EOS4 751 XS2	EOS4 901 XS2	EOS4 1051 XS2	EOS4 1201 XS2	EOS4 1351 XS2	EOS4 1501 XS2	EOS4 1651 XS2	EOS4 1801 XS2	EOS4 1951 XS2
Part number	-	-	1310041	1310042	1310043	1310044	1310045	1310046	1310047	1310048	1310049	1310078	1310079	1310730
Protected height (mm)	160		310	460	610	760	910	1060	1210	1360	1510	1660	1810	1960
Number of beams	15		30	45	60	75	90	105	120	135	150	165	180	195
Overall height (mm)														
Master / Slave 2 *	236,5		386,5	536,5	686,5	836,5	986,5	1136,5	1286,5	1436,5	1586,5	1736,5	1886,5	2036,5

* On Slave versions, the overall height of the light curtain is the same of the standard model.
On Master and Slave 2, the total height of the light curtain is greater due to the addition of the secondary connector.



Resolution 30 mm

MASTER	-	EOS4 253 XM	EOS4 303 XM	EOS4 453 XM	EOS4 603 XM	EOS4 753 XM	EOS4 903 XM	EOS4 1053 XM	EOS4 1203 XM	EOS4 1353 XM	EOS4 1503 XM	EOS4 1653 XM	EOS4 1803 XM	EOS4 1953 XM	EOS4 2103 XM	EOS4 2253 XM
Part number		1311206	1310221	1310222	1310223	1310224	1310225	1310226	1310227	1310228	1310229	1310274	1310275	1310742	1310743	1310744
SLAVE	EOS4 153 XS	EOS4 253 XS	EOS4 303 XS	EOS4 453 XS	EOS4 603 XS	EOS4 753 XS	EOS4 903 XS	EOS4 1053 XS	EOS4 1203 XS	EOS4 1353 XS	EOS4 1503 XS	EOS4 1653 XS	EOS4 1803 XS	EOS4 1953 XS	EOS4 2103 XS	EOS4 2253 XS
Part number	1310230	1311207	1310231	1310232	1310233	1310234	1310235	1310236	1310237	1310238	1310239	1310276	1310277	1310745	1310746	1310747
SLAVE 2	-	EOS4 253 XM2	EOS4 303 XS2	EOS4 453 XS2	EOS4 603 XS2	EOS4 753 XS2	EOS4 903 XS2	EOS4 1053 XS2	EOS4 1203 XS2	EOS4 1353 XS2	EOS4 1503 XS2	EOS4 1653 XS2	EOS4 1803 XS2	EOS4 1953 XS2	EOS4 2103 XS2	EOS4 2253 XS2
Part number	-	1311208	1310241	1310242	1310243	1310244	1310245	1310246	1310247	1310248	1310249	1310278	1310279	1310748	1310749	1310750
Protected height (mm)	160	260	310	460	610	760	910	1060	1210	1360	1510	1660	1810	1960	2110	2260
Number of beams	8	13	16	23	31	38	46	53	61	68	76	83	91	98	106	113
Overall height (mm) Master / Slave 2 *	236,5	336,5	386,5	536,5	686,5	836,5	986,5	1136,5	1286,5	1436,5	1586,5	1736,5	1886,5	2036,5	2186,5	2336,5



Resolution 40 mm

MASTER	-	EOS4 254 XM	EOS4 304 XM	EOS4 454 XM	EOS4 604 XM	EOS4 754 XM	EOS4 904 XM	EOS4 104 XM	EOS4 1204 XM	EOS4 1354 XM	EOS4 1504 XM	EOS4 1654 XM	EOS4 1804 XM	EOS4 1954 XM	EOS4 2104 XM	EOS4 2254 XM
Part number		1311210	1310321	1310322	1310323	1310324	1310325	1310326	1310327	1310328	1310329	1310374	1310375	1310760	1310761	1310762
SLAVE	EOS4 154 XS	EOS4 254 XS	EOS4 304 XS	EOS4 454 XS	EOS4 604 XS	EOS4 754 XS	EOS4 904 XS	EOS4 1054 XS	EOS4 1204 XS	EOS4 1354 XS	EOS4 1504 XS	EOS4 1654 XS	EOS4 1804 XS	EOS4 1954 XS	EOS4 2104 XS	EOS4 2254 XS
Part number	1310330	1311211	1310331	1310332	1310333	1310334	1310335	1310336	1310337	1310338	1310339	1310376	1310377	1310763	1310764	1310765
SLAVE 2	-	EOS4 254 XM2	EOS4 304 XS2	EOS4 454 XS2	EOS4 604 XS2	EOS4 754 XS2	EOS4 904 XS2	EOS4 1054 XS2	EOS4 1204 XS2	EOS4 1354 XS2	EOS4 1504 XS2	EOS4 1654 XS2	EOS4 1804 XS2	EOS4 1954 XS2	EOS4 2104 XS2	EOS4 2254 XS2
Part number	-	1311212	1310341	1310342	1310343	1310344	1310345	1310346	1310347	1310348	1310349	1310378	1310379	1310766	1310767	1310768
Protected height (mm)	160	260	310	460	610	760	910	1060	1210	1360	1510	1660	1810	1960	2110	2260
Number of beams	6	9	11	16	21	26	31	36	41	46	51	56	61	66	71	76
Overall height (mm) Master / Slave 2 *	236,5	336,5	386,5	536,5	686,5	836,5	986,5	1136,5	1286,5	1436,5	1586,5	1736,5	1886,5	2036,5	2186,5	2336,5



Resolution 50 mm

MASTER	-	-	EOS4 305 XM	EOS4 455 XM	EOS4 605 XM	EOS4 755 XM	EOS4 905 XM	EOS4 105 XM	EOS4 1205 XM	EOS4 1355 XM	EOS4 1505 XM	EOS4 1655 XM	EOS4 1805 XM	EOS4 1955 XM	EOS4 2105 XM	EOS4 2255 XM
Part number			1310421	1310422	1310423	1310424	1310425	1310426	1310427	1310428	1310429	1310474	1310475	1310781	1310782	1310783
SLAVE	EOS4 155 XS	-	EOS4 305 XS	EOS4 455 XS	EOS4 605 XS	EOS4 755 XS	EOS4 905 XS	EOS4 1055 XS	EOS4 1205 XS	EOS4 1355 XS	EOS4 1505 XS	EOS4 1655 XS	EOS4 1805 XS	EOS4 1955 XS	EOS4 2105 XS	EOS4 2255 XS
Part number	1310430	-	1310431	1310432	1310433	1310434	1310435	1310436	1310437	1310438	1310439	1310476	1310477	1310784	1310785	1310786
SLAVE 2	-	-	EOS4 305 XS2	EOS4 455 XS2	EOS4 605 XS2	EOS4 755 XS2	EOS4 905 XS2	EOS4 1055 XS2	EOS4 1205 XS2	EOS4 1355 XS2	EOS4 1505 XS2	EOS4 1655 XS2	EOS4 1805 XS2	EOS4 1955 XS2	EOS4 2105 XS2	EOS4 2255 XS2
Part number	-	-	1310441	1310442	1310443	1310444	1310445	1310446	1310447	1310448	1310449	1310478	1310479	1310787	1310788	1310789
Protected height (mm)	160		310	460	610	760	910	1060	1210	1360	1510	1660	1810	1960	2110	2260
Number of beams	4		8	12	16	20	24	28	32	36	40	44	48	52	56	60
Overall height (mm) Master / Slave 2 *	236,5		386,5	536,5	686,5	836,5	986,5	1136,5	1286,5	1436,5	1586,5	1736,5	1886,5	2036,5	2186,5	2336,5



Resolution 90 mm

MASTER	-	-	EOS4 309 XM	EOS4 459 XM	EOS4 609 XM	EOS4 759 XM	EOS4 909 XM	EOS4 1059 XM	EOS4 1209 XM	EOS4 1359 XM	EOS4 1509 XM	EOS4 1659 XM	EOS4 1809 XM	EOS4 1959 XM	EOS4 2109 XM	EOS4 2259 XM
Part number	-	-	1310521	1310522	1310523	1310524	1310525	1310526	1310527	1310528	1310529	1310574	1310575	1310801	1310802	1310803
SLAVE	-	-	EOS4 309 XS	EOS4 459 XS	EOS4 609 XS	EOS4 759 XS	EOS4 909 XS	EOS4 1059 XS	EOS4 1209 XS	EOS4 1359 XS	EOS4 1509 XS	EOS4 1659 XS	EOS4 1809 XS	EOS4 1959 XS	EOS4 2109 XS	EOS4 2259 XS
Part number	-	-	1310531	1310532	1310533	1310534	1310535	1310536	1310537	1310538	1310539	1310576	1310577	1310804	1310805	1310806
SLAVE 2	-	-	EOS4 309 XS2	EOS4 459 XS2	EOS4 609 XS2	EOS4 759 XS2	EOS4 909 XS2	EOS4 1059 XS2	EOS4 1209 XS2	EOS4 1359 XS2	EOS4 1509 XS2	EOS4 1659 XS2	EOS4 1809 XS2	EOS4 1959 XS2	EOS4 2109 XS2	EOS4 2259 XS2
Part number	-	-	1310541	1310542	1310543	1310544	1310545	1310546	1310547	1310548	1310549	1310578	1310579	1310807	1310808	1310809
Protected height (mm)			310	460	610	760	910	1060	1210	1360	1510	1660	1810	1960	2110	2260
Number of beams			4	6	8	10	12	14	16	18	20	22	24	52	56	60
Overall height (mm) Master / Slave 2 *			386,5	536,5	686,5	836,5	986,5	1136,5	1286,5	1436,5	1586,5	1736,5	1886,5	2036,5	2186,5	2336,5

EOS4 - EOS2

PART NUMBERS

EOS2 - MASTER/SLAVE VERSIONS WITH INTEGRATED FUNCTIONS



Resolution 30 mm

MASTER	-	EOS 2 253 XM	EOS2 303 XM	EOS2 453 XM	EOS2 603 XM	EOS2 753 XM	EOS2 903 XM	EOS2 1053 XM	EOS2 1203 XM	EOS2 1353 XM	EOS2 1503 XM	EOS2 1653 XM	EOS2 1803 XM	EOS2 1953 XM	EOS2 2103 XM	EOS2 2253 XM
Part number	-	1321206	1320221	1320222	1320223	1320224	1320225	1320226	1320227	1320228	1320229	1320274	1320275	1320742	1320743	1320744
SLAVE	EOS2 153 XS	EOS 2 253 XS	EOS2 303 XS	EOS2 453 XS	EOS2 603 XS	EOS2 753 XS	EOS2 903 XS	EOS2 1053 XS	EOS2 1203 XS	EOS2 1353 XS	EOS2 1503 XS	EOS2 1653 XS	EOS2 1803 XS	EOS2 1953 XS	EOS2 2103 XS	EOS2 2253 XS
Part number	1320230	1321207	1320231	1320232	1320233	1320234	1320235	1320236	1320237	1320237	1320239	1320276	1320277	1320745	1320746	1320747
SLAVE 2	-	EOS 2 253 XM2	EOS2 303 XS2	EOS2 453 XS2	EOS2 603 XS2	EOS2 753 XS2	EOS2 903 XS2	EOS2 1053 XS2	EOS2 1203 XS2	EOS2 1353 XS2	EOS2 1503 XS2	EOS2 1653 XS2	EOS2 1803 XS2	EOS2 1953 XS2	EOS2 2103 XS2	EOS2 2253 XS2
Part number	-	1321208	1320241	1320242	1320243	1320244	1320245	1320246	1320247	1320248	1320249	1320278	1320279	1320748	1320749	1320750
Protected height (mm)	160	260	310	460	610	760	910	1060	1210	1360	1510	1660	1810	1960	2110	2260
Number of beams	8	13	16	23	31	38	46	53	61	68	76	83	91	98	106	113
Overall height (mm) Master / Slave 2 *	236.5	336.5	386.5	536.5	686.5	836.5	986.5	1136.5	1286.5	1436.5	1586.5	1736.5	1886.5	2013	2163	2313



Resolution 40 mm

MASTER	-	EOS2 254 XM	EOS2 304 XM	EOS2 454 XM	EOS2 604 XM	EOS2 754 XM	EOS2 904 XM	EOS2 1054 XM	EOS2 1204 XM	EOS2 1354 XM	EOS2 1504 XM	EOS2 1654 XM	EOS2 1804 XM	EOS2 1954 XM	EOS2 2104 XM	EOS2 2254 XM
Part number	-	1321210	1320321	1320322	1320323	1320324	1320325	1320326	1320327	1320328	1320329	1320374	1320375	1320760	1320761	1320762
SLAVE	EOS2 154 XS	EOS2 254 XS	EOS2 304 XS	EOS2 454 XS	EOS2 604 XS	EOS2 754 XS	EOS2 904 XS	EOS2 1054 XS	EOS2 1204 XS	EOS2 1354 XS	EOS2 1504 XS	EOS2 1654 XS	EOS2 1804 XS	EOS2 1954 XS	EOS2 2104 XS	EOS2 2254 XS
Part number	1320330	1321211	1320331	1320332	1320333	1320334	1320335	1320336	1320337	1320338	1320339	1320376	1320377	1320763	1320764	1320765
SLAVE 2	-	EOS2 254 XS2	EOS2 304 XS2	EOS2 454 XS2	EOS2 604 XS2	EOS2 754 XS2	EOS2 904 XS2	EOS2 1054 XS2	EOS2 1204 XS2	EOS2 1354 XS2	EOS2 1504 XS2	EOS2 1654 XS2	EOS2 1804 XS2	EOS2 1954 XS2	EOS2 2104 XS2	EOS2 2254 XS2
Part number	-	1321212	1320341	1320342	1320343	1320344	1320345	1320346	1320347	1320348	1320349	1320378	1320379	1320766	1320767	1320768
Protected height (mm)	160	260	310	460	610	760	910	1060	1210	1360	1510	1660	1810	1960	2110	2260
Number of beams	6	9	11	16	21	26	31	36	41	46	51	56	61	66	71	76
Overall height (mm) Master / Slave 2 *	236.5	336.5	386.5	536.5	686.5	836.5	986.5	1136.5	1286.5	1436.5	1586.5	1736.5	1886.5	2013	2163	2313



Resolution 50 mm

MASTER	-	-	EOS2 305 XM	EOS2 455 XM	EOS2 605 XM	EOS2 755 XM	EOS2 905 XM	EOS2 105 XM	EOS2 1205 XM	EOS2 1355 XM	EOS2 1505 XM	EOS2 1655 XM	EOS2 1805 XM	EOS2 1955 XM	EOS2 2105 XM	EOS2 2255 XM
Part number	-	-	1320421	1320422	1320423	1320424	1320425	1320426	1320427	1320428	1320429	1320474	1320475	1320781	1320782	1320783
SLAVE	EOS2 155 XS	-	EOS2 305 XS	EOS2 455 XS	EOS2 605 XS	EOS2 755 XS	EOS2 905 XS	EOS2 1055 XS	EOS2 1205 XS	EOS2 1355 XS	EOS2 1505 XS	EOS2 1655 XS	EOS2 1805 XS	EOS2 1955 XS	EOS2 2105 XS	EOS2 2255 XS
Part number	1320430	-	1320431	1320432	1320433	1320434	1320435	1320436	1320437	1320438	1320439	1320476	1320477	1320784	1320785	1320786
SLAVE 2	-	-	EOS2 305 XS2	EOS2 455 XS2	EOS2 605 XS2	EOS2 755 XS2	EOS2 905 XS2	EOS2 1055 XS2	EOS2 1205 XS2	EOS2 1355 XS2	EOS2 1505 XS2	EOS2 1655 XS2	EOS2 1805 XS2	EOS2 1955 XS2	EOS2 2105 XS2	EOS2 2255 XS2
Part number	-	-	1320441	1320442	1320443	1320444	1320445	1320446	1320447	1320448	1320449	1320478	1320479	1320787	1320788	1320789
Protected height (mm)	160	-	310	460	610	760	910	1060	1210	1360	1510	1660	1810	1960	2110	2260
Number of beams	4	-	8	12	16	20	24	28	32	36	40	44	48	52	56	60
Overall height (mm) Master / Slave 2 *	236.5	-	386.5	536.5	686.5	836.5	986.5	1136.5	1286.5	1436.5	1586.5	1736.5	1886.5	2013	2163	2313



Resolution 90 mm

MASTER	-	-	EOS2 309 XM	EOS2 459 XM	EOS2 609 XM	EOS2 759 XM	EOS2 909 XM	EOS2 1059 XM	EOS2 1209 XM	EOS2 1359 XM	EOS2 1509 XM	EOS2 1659 XM	EOS2 1809 XM	EOS2 1959 XM	EOS2 2109 XM	EOS2 2259 XM
Part number	-	-	1320521	1320522	1320523	1320524	1320525	1320526	1320527	1320528	1320529	1320574	1320575	1320801	1320802	1320803
SLAVE	-	-	EOS2 309 XS	EOS2 459 XS	EOS2 609 XS	EOS2 759 XS	EOS2 909 XS	EOS2 1059 XS	EOS2 1209 XS	EOS2 1359 XS	EOS2 1509 XS	EOS2 1659 XS	EOS2 1809 XS	EOS2 1959 XS	EOS2 2109 XS	EOS2 2259 XS
Part number	-	-	1320531	1320532	1320533	1320534	1320535	1320536	1320537	1320538	1320539	1320576	1320577	1320804	1320805	1320806
SLAVE 2	-	-	EOS2 309 XS2	EOS2 459 XS2	EOS2 609 XS2	EOS2 759 XS2	EOS2 909 XS2	EOS2 1059 XS2	EOS2 1209 XS2	EOS2 1359 XS2	EOS2 1509 XS2	EOS2 1659 XS2	EOS2 1809 XS2	EOS2 1959 XS2	EOS2 2109 XS2	EOS2 2259 XS2
Part number	-	-	1320541	1320542	1320543	1320544	1320545	1320546	1320547	1320548	1320549	1320578	1320579	1320807	1320808	1320809
Protected height (mm)	-	-	310	460	610	760	910	1060	1210	1360	1510	1660	1810	1960	2110	2260
Number of beams	-	-	4	6	8	10	12	14	16	18	20	22	24	26	28	30
Overall height (mm) Master / Slave 2 *	-	-	386.5	536.5	686.5	836.5	986.5	1136.5	1266.5	1436.5	1586.5	1736.5	1886.5	2013	2163	2313

EOS4 - MASTER/SLAVE MULTIBEAMS



2, 3, 4 beams

MASTER	EOS4 2B XM	EOS4 3B XM	EOS4 4B XM
Part number	1310620	1310621	1310622
SLAVE	EOS4 2B XS	EOS4 3B XS	EOS4 4B XS
Part number	1310630	1310631	1310632
SLAVE 2	EOS4 2B XS2	EOS4 3B XS2	EOS4 4B XS2
Part number	1310640	1310641	1310642
Number of beams	2	3	4
Beam spacing (mm)	500	400	300
Protected height (mm)	510	810	910
Overall height (mm) Master / Slave 2*	677	977	1077

EOS2 - MASTER/SLAVE MULTIBEAMS



2, 3, 4 beams

MASTER	EOS2 2B XM	EOS2 3B XM	EOS2 4B XM
Part number	1320620	1320621	1320622
SLAVE	EOS2 2B XS	EOS2 3B XS	EOS2 4B XS
Part number	1320630	1320631	1320632
SLAVE 2	EOS2 2B XS2	EOS2 3B XS2	EOS2 4B XS2
Part number	1320640	1320641	1320642
Number of beams	2	3	4
Beam spacing (mm)	500	400	300
Protected height (mm)	510	810	910
Overall height (mm) Master / Slave 2*	677	977	1077

* On Slave versions, the overall height of the light curtain is the same of the standard model.
On Master and Slave 2, the total height of the light curtain is greater due to the addition of the secondary connector.

EOS4 / EOS2 - T (HIGH VIBRATIONS)



Resolution 30 mm

AT versions	EOS4 153 AT	EOS4 303 AT	EOS4 453 AT	EOS4 603 AT
Part number	1310821	1310822	1310823	1310824
ATL versions	EOS4 153 ATL	EOS4 303 ATL	EOS4 453 ATL	EOS4 603 ATL
Part number	1310825	1310826	1310827	1310828
XT versions	EOS4 153 XT	EOS4 303 XT	EOS4 453 XT	EOS4 603 XT
Part number	1310816	1310817	1310818	1310810
XTL versions	EOS4 153 XTL	EOS4 303 XTL	EOS4 453 XTL	EOS4 603 XTL
Part number	1310819	1310702	1310820	1310815
AT versions	EOS2 153 AT	EOS2 303 AT	EOS2 453 AT	EOS2 603 AT
Part number	1321222	1321201	1321223	1321224
ATL versions	EOS2 153 ATL	EOS2303 ATL	EOS2453 ATL	EOS2603 ATL
Part number	1321225	1321226	1321227	1321228
XT versions	EOS2 153 XT	EOS2 303 XT	EOS2 453 XT	EOS2 603 XT
Part number	1321214	1321213	1321216	1321217
XTL versions	EOS2 153 XTL	EOS2 303 XTL	EOS2 453 XTL	EOS2 603 XTL
Part number	1321218	1321219	1321220	1321221
Protected height (mm)	160	310	460	610
Number of beams	8	16	23	31
Overall height (mm)	213	363	513	663

EOS4 - ATEX VERSIONS*



Resolution 30 mm

AH EX versions	EOS4 603 AH EX	EOS4 903 AH EX	EOS4 1203 AH EX	EOS4 1503 AH EX
Part number	1010253	1010255	1010257	1010259
Protected height (mm)	610	910	1210	1510
Number of beams	31	46	61	76
Overall height (mm)	780	1080	1380	1680



2, 3, 4 beams

AH EX versions	EOS4 2B AH EX	EOS4 3B AH EX	EOS4 4B AH EX
Part number	1010650	1010651	1010652
Number of beams	2	3	4
Beam spacing (mm)	500	400	300
Protected height (mm)	510	810	910
Overall height (mm)	780	1080	1180

* Note: The safety light curtain/grid is delivered already enclosed into its watertight tube with a 10m long prewired cable and the related fastening brackets

EOS4 / EOS2 - WTF / WTHF VERSIONS*



Resolution 14 mm

X WTF versions	EOS4 151 X WTF	EOS4 301 X WTF	EOS4 451 X WTF	EOS4 601 X WTF	EOS4 751 X WTF	EOS4 901 X WTF	EOS4 1051 X WTF	EOS4 1201 X WTF	EOS4 1351 X WTF	EOS4 1501 X WTF	EOS4 1651 X WTF	EOS4 1801 X WTF
Part number	1110030	1110031	1110032	1110033	1110034	1110035	1110036	1110037	1110038	1110039	1110051	1110052
X WTHF versions	EOS4 151 X WTHF	EOS4 301 X WTHF	EOS4 451 X WTHF	EOS4 601 X WTHF	EOS4 751 X WTHF	EOS4 901 X WTHF	EOS4 1051 X WTHF	EOS4 1201 X WTHF	EOS4 1351 X WTHF	EOS4 1501 X WTHF	EOS4 1651 X WTHF	EOS4 1801 X WTHF
Part number	1110040	1110041	1110042	1110043	1110044	1110045	1110046	1110047	1110048	1110049	1110055	1110056
Protected height (mm)	160	310	460	610	760	910	1060	1210	1360	1510	1660	1810
Number of beams	15	30	45	60	75	90	105	120	135	150	165	180
Overall height (mm)	337	487	637	787	937	1087	1237	1387	1537	1687	1837	1987

EOS4 - EOS2

PART NUMBERS



Resolution 30 mm

XH WTF versions	EOS4 153 XH WTF	EOS4 303 XH WTF	EOS4 453 XH WTF	EOS4 603 XH WTF	EOS4 753 XH WTF	EOS4 903 XH WTF	EOS4 1053 XH WTF	EOS4 1203 XH WTF	EOS4 1353 XH WTF	EOS4 1503 XH WTF	EOS4 1653 XH WTF	EOS4 1803 XH WTF
Part number	1110280	1110281	1110282	1110283	1110284	1110285	1110286	1110287	1110288	1110289	1110053	1110054
XH WTHF versions	EOS4 153 XH WTHF	EOS4 303 XH WTHF	EOS4 453 XH WTHF	EOS4 603 XH WTHF	EOS4 753 XH WTHF	EOS4 903 XH WTHF	EOS4 1053 XH WTHF	EOS4 1203 XH WTHF	EOS4 1353 XH WTHF	EOS4 1503 XH WTHF	EOS4 1653 XH WTHF	EOS4 1803 XH WTHF
Part number	1110290	1110291	1110292	1110293	1110294	1110295	1110296	1110297	1110298	1110299	1110057	1110058
Protected height (mm)	160	310	460	610	760	910	1060	1210	1360	1510	1660	1810
Number of beams	8	16	23	31	38	46	53	61	68	76	83	91
Overall height (mm)	337	487	637	787	937	1087	1237	1387	1537	1687	1837	1987



Resolution 30 mm

XH WTF versions	EOS2 153 X WTF	EOS2 303 X WTF	EOS2 453 X WTF	EOS2 603 X WTF	EOS2 753 X WTF	EOS2 903 X WTF	EOS2 1053 X WTF	EOS2 1203 X WTF	EOS2 1353 X WTF	EOS2 1503 X WTF	EOS2 1653 X WTF	EOS2 1803 X WTF
Part number	1120230	1120231	1120232	1120233	1120234	1120235	1120236	1120237	1120238	1120239	1120050	1120051
XH WTHF versions	EOS2 153 X WTHF	EOS2 303 X WTHF	EOS2 453 X WTHF	EOS2 603 X WTHF	EOS2 753 X WTHF	EOS2 903 X WTHF	EOS2 1053 X WTHF	EOS2 1203 X WTHF	EOS2 1353 X WTHF	EOS2 1503 X WTHF	EOS2 1653 X WTHF	EOS2 1803 X WTHF
Part number	1120240	1120241	1120242	1120243	1120244	1120245	1120246	1120247	1120248	1120249	1120052	1120053
Protected height (mm)	160	310	460	610	760	910	1060	1210	1360	1510	1660	1810
Number of beams	8	16	23	31	38	46	53	61	68	76	83	91
Overall height (mm)	337	487	637	787	937	1087	1237	1387	1537	1687	1837	1987

EOS4 - WTF / WTHF MULTIBEAMS



2, 3, 4 beams

	WTF versions			WTHF versions		
	EOS4 2B XH WTF	EOS4 3B XH WTF	EOS4 4B XH WTF	EOS4 2B XH WTHF	EOS4 3B XH WTHF	EOS4 4B XH WTHF
Part number	1110670	1110671	1110672	1110675	1110676	1110677
Number of beams	2	3	4	2	3	4
Beam spacing (mm)	500	400	300	500	400	300
Protected height (mm)	510	810	910	510	810	910
Overall height (mm)	777	1077	1177	777	1077	1177

EOS2 - WTF / WTHF MULTIBEAMS



2, 3, 4 beams

	WTF versions			WTHF versions		
	EOS2 2B X WTF	EOS2 3B X WTF	EOS2 4B X WTF	EOS2 2B X WTHF	EOS2 3B X WTHF	EOS2 4B X WTHF
Part number	1120620	1120621	1120622	1120625	1120626	1120627
Number of beams	2	3	4	2	3	4
Beam spacing (mm)	500	400	300	500	400	300
Protected height (mm)	510	810	910	510	810	910
Overall height (mm)	777	1077	1177	777	1077	1177

* Note: The safety light curtain/grid is delivered already enclosed into its watertight tube with a 10m long prewired cable and the related fastening brackets

AVAILABLE ACCESSORIES

- Connecting cables
- Special mounting brackets
- Floor mounting columns
- Heavy-duty protection screens
- Laser alignment aid
- Vibration dampers

See [page 41](#)



ACCESS CONTROL BARRIERS

The Safegate Type 4 range of access control barriers is the ideal solution for the protection of a vast number of high-risk industrial applications, in particular those requiring a high level of integration of the Muting functions.

Safegate guarantees the perfect integration of all Muting sensors directly connected to the access control barrier.

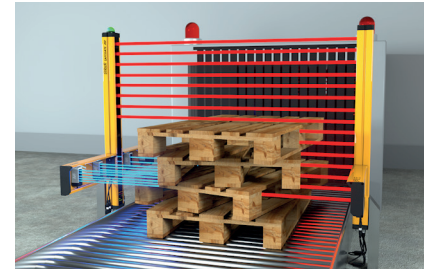

VERSIONS AVAILABLE



Without Muting functions



Hardware configuration

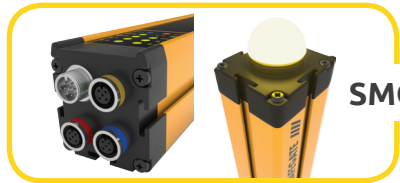

Hardware configuration with integrated Status and Muting lamp

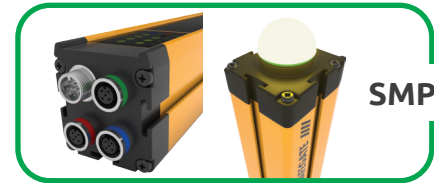

Hardware or Software configuration with integrated Status and Muting lamp

Also available as **TRX** with passive retro-reflective elements

Integrated Status and Muting lamp

Fully scalable
Change configuration at any time

Vast range of accessories including
- connection boxes
- special mounting brackets
- floor mounting columns

Flexible configuration
Hardware or Software configuration to cover all Muting applications

Color-coding

Color-coded connectors for easy installation



LONG RANGE

Special version with range up to 80 m (without Muting functions)

Pre-configured and pre-wired Muting arms

3 pre-configured Muting logics
- Exit-only (parallel/crossed beams)
- Entry-Exit (parallel beams)
- Entry-Exit (crossed beams)

M⁵ multi-beam Muting sensors
Ideal for sensing unconventional objects
Also available in TRX version with retro-reflective Muting sensors **M^{TRX}**

Safegate Configuration Software (SCS) for SMPO versions

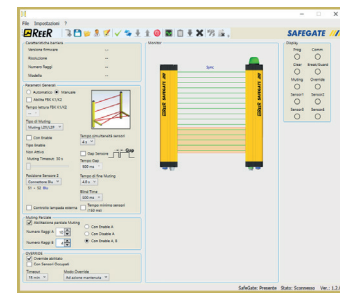

Configuration with MA Muting Arms with integrated single-beam sensors

Watch the video!

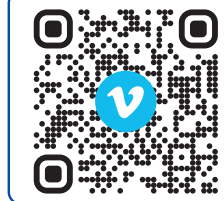

Configuration with MZ Muting Brackets with M⁵ multi-beam sensors or M^{TRX} retro-reflector sensors

SAFETY LEVEL

TYPE 4
SIL 3 - SILCL 3
PL e - Cat. 4



SAFEGATE

MUTING SENSORS AND ACCESSORIES

MUTING SENSORS

MA

Muting arms with integrated sensors



MA L2X
[1390800]
2 integrated sensors (emitter and receiver)

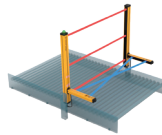

L Muting logic
Crossed beams
One-way
Exit-only
Range (m) 1 ... 2,5

MA T2X
[1390802]
2 integrated sensors (emitter and receiver)

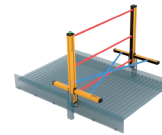

T Muting logic
Crossed beams
Two-way
Entry-Exit
Range (m) 1 ... 2,5



MA L2P TRX
[1390804]
2 integrated retro-reflector sensors

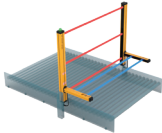

L Muting logic
Parallel beams
One-way
Exit-only
Range (m) 0 ... 3,5

MA T4P TRX
[1390805]
4 integrated retro-reflector sensors

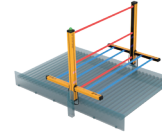

T Muting logic
Parallel beams
Two-way
Entry-Exit
Range (m) 0 ... 3,5

MZ

Muting brackets with M⁵ or M^{TRX} sensors



MZ L2XP
[1390808]
2 M⁵ multi-beam sensors

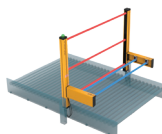

L Muting logic
Crossed or Parallel beams
One-way
Exit-only
Range (m) 0 ... 3,5

MZ T2X
[1390809]
2 M⁵ multi-beam sensors

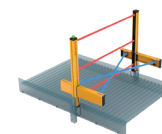

T Muting logic
Crossed beams
Two-way
Entry-Exit
Range (m) 0 ... 3,5

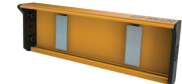

MZ L2XP TRX
[1390815]
2 M^{TRX} retro-reflector sensors

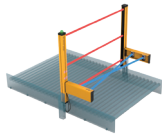

MZ T2X TRX
[1390816]
2 M^{TRX} retro-reflector sensors

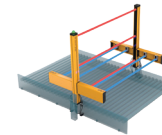

T Muting logic
Parallel beams
Two-way
Entry-Exit
Range (m) 0 ... 3,5

MZ T4P
[1390810]
4 M⁵ multi-beam sensors

MZ T4P TRX
[1390817]
4 M^{TRX} retro-reflector sensors

For Muting sensors M⁵ and M^{TRX} see page page 38

SPECIAL MUTING SENSORS

Model	Part number	Used for..
MA L2P TRX G	1390813	Transparent material (range 0 ... 2 m)
MA T4P TRX G	1390814	
MZ L2XP TRX G	1390818	
MZ T2X TRX G	1390819	
MZ T4P TRX G	1390820	
MA L2P TRX V	1390806	High speed conveyors (range 0 ... 3,5 m)
MA T4P TRX V	1390807	
MZ L2XP V	1390811	
MZ T4P V	1390812	

Model	Part number	Used for..
MA L2P TRX VG	1390821	High speed conveyors for transparent material (range 0 ... 2 m)
MA T4P TRX VG	1390822	
MZ L2XP H	1390823	High range (range 0 ... 5 m)
MZ L2XP TRX H	1390826	
MZ T2X H	1390824	
MZ T2X TRX H	1390828	
MZ T4P H	1390825	
MZ T4P TRX H	1390827	

CABLES NEEDED

SM / SMO / SMPO	S	LR / LR ILP
Emitter: M12 5-pole (CDx)	M12 5-pole (CDx)	M12 5-pole (CDx)
Receiver: M12 12-pole (CS12Dx)	M12 8-pole (C8Dx)	M12 8-pole (C8Dx)
SM TRX / SMO TRX / SMPO TRX		
Active element: M12 12-pole (CS12Dx)		
S TRX		S TRX - A
Active element: M12 8-pole (C8Dx)		M12 5-pole (CDx)
CS12USB [1390905] USB-M12 5-pole - SMPO e SMPO TRX versions programming cable		

CONNECTION BOXES



Models	M SG BOX	M SGO BOX	M SG BOX RST	M SG BOX PLUS	M SGO BOX PLUS	M SG BOX OSSD	M SGO BOX OSSD	M SG BOX RST P
Part number	1390953	1390952	1390959	1390955	1390556	1390957	1390958	1390960
Lamp	no	yes	no	no	yes	no	yes	no
Safety outputs *	Relè - 2 NA + 1 NC 2A - 250 Vca			Relè - 4 NA + 1 NC 2A - 250 Vca		2 OSSD 2 PNP 400mA - 24Vcc		
For light curtains models...	All excepted S version		S and S TRX version	All excepted S version			S TRX-A version	
Override	yes		no	yes			no	
I/O modules connection	no			no			yes	
Receiver or TRX active element connector	CFF12Px		CFF8Px	CFF12Px			CJBEx	
Emitter connector	CFM5Px			CFM5Px			no	
Aux. lamp connector	no	CFM5Px	no	CFM5Px	no	CFM5Px	no	
I/O module connector	no			no			CFM5Px	

* Each NO safety output line is interrupted twice by the integrated relays

PART NUMBERS

Resolution 14 mm

SM versions	SM 301	SM 451	SM 601	SM 751	SM 901	SM 1051	SM 1201	SM 1351	SM 1501	SM 1651	SM 1801	SM 1951
Part number	1390021	1390022	1390023	1390024	1390025	1390026	1390027	1390028	1390029	1390030	1390031	1390032
S MO versions	S MO 301	S MO 451	S MO 601	S MO 751	S MO 901	S MO 1051	S MO 1201	S MO 1351	S MO 1501	S MO 1651	S MO 1801	S MO 1951
Part number	1390041	1390042	1390043	1390044	1390045	1390046	1390047	1390048	1390049	1390050	1390051	1390052
SMPO versions	SMPO 301	SMPO 451	SMPO 601	SMPO 751	SMPO 901	SMPO 1051	SMPO 1201	SMPO 1351	SMPO 1501	SMPO 1651	SMPO 1801	SMPO 1951
Part number	1390081	1390082	1390083	1390084	1390085	1390086	1390087	1390088	1390089	1390090	1390091	1390092
Protected height (mm)	310	460	610	760	910	1060	1210	1360	1510	1660	1810	1960
Number of beams	30	45	60	75	90	105	120	135	150	165	180	195
Overall height (mm)*	420	570	720	870	1020	1170	1320	1470	1620	1770	1920	2070

* with lamp

Resolution 30 mm

S versions	S 303	S 453	S 603	S 753	S 903	S 1053	S 1203	S 1353	S 1503	S 1653	S 1803	S 1953	S 2103	S 2253
Part number	1390201	1390202	1390203	1390204	1390205	1390206	1390207	1390208	1390209	1390210	1390211	1390212	1390213	
SM versions	SM 303	SM 453	SM 603	SM 753	SM 903	SM 1053	SM 1203	SM 1353	SM 1503	SM 1653	SM 1803	SM 1953	SM 2103	SM 2253
Part number	1390221	1390222	1390223	1390224	1390225	1390226	1390227	1390228	1390229	1390230	1390231	1390232	1390233	1390234
S MO versions	S MO 303	S MO 453	S MO 603	S MO 753	S MO 903	S MO 1053	S MO 1203	S MO 1353	S MO 1503	S MO 1653	S MO 1803	S MO 1953	S MO 2103	S MO 2253
Part number	1390241	1390242	1390243	1390244	1390245	1390246	1390247	1390248	1390249	1390250	1390251	1390252	1390253	1390254
SMPO versions	SMPO 303	SMPO 453	SMPO 603	SMPO 753	SMPO 903	SMPO 1053	SMPO 1203	SMPO 1353	SMPO 1503	SMPO 1653	SMPO 1803	SMPO 1953	SMPO 2103	SMPO 2253
Part number	1390281	1390282	1390283	1390284	1390285	1390286	1390287	1390288	1390289	1390290	1390291	1390292	1390293	1390294
Protected height (mm)	310	460	610	760	910	1060	1210	1360	1510	1660	1810	1960	2110	2260
Number of beams	16	23	31	38	46	53	61	68	76	83	91	98	106	113
Overall height (mm)*	420	570	720	870	1020	1170	1320	1470	1620	1770	1920	2070	2220	2370

* with lamp

Resolution 40 mm

S version	S 304	S 454	S 604	S 754	S 904	S 1054	S 1204	S 1354	S 1504	S 1654	S 1804	S 1954	S 2104	S 2254
Part number	1390301	1390302	1390303	1390304	1390305	1390306	1390307	1390308	1390309	1390310	1390311	1390312	1390313	1390314
SM versions	SM 304	SM 454	SM 604	SM 754	SM 904	SM 1054	SM 1204	SM 1354	SM 1504	SM 1654	SM 1804	SM 1954	SM 2104	SM 2254
Part number	1390321	1390322	1390323	1390324	1390325	1390326	1390327	1390328	1390329	1390330	1390331	1390332	1390333	1390334
S MO versions	S MO 304	S MO 454	S MO 604	S MO 754	S MO 904	S MO 1054	S MO 1204	S MO 1354	S MO 1504	S MO 1654	S MO 1804	S MO 1954	S MO 2104	S MO 2254
Part number	1390341	1390342	1390343	1390344	1390345	1390346	1390347	1390348	1390349	1390350	1390351	1390352	1390353	1390354
SMPO versions	SMPO 304	SMPO 454	SMPO 604	SMPO 754	SMPO 904	SMPO 1054	SMPO 1204	SMPO 1354	SMPO 1504	SMPO 1654	SMPO 1804	SMPO 1954	SMPO 2104	SMPO 2254
Part number	1390381	1390382	1390383	1390384	1390385	1390386	1390387	1390388	1390389	1390390	1390391	1390392	1390393	1390394
Protected height (mm)	310	460	610	760	910	1060	1210	1360	1510	1660	1810	1960	2110	2260
Number of beams	11	16	21	26	31	36	41	46	51	56	61	66	71	76
Overall height (mm)*	420	570	720	870	1020	1170	1320	1470	1620	1770	1920	2070	2220	2370

* with lamp

2, 3, 4 beams

S versions	S 2B	S 3B	S 4B
Part number	1390600	1390601	1390602
SM versions	SM 2B	SM 3B	SM 4B
Part number	1390620	1390621	1390622
S MO versions	S MO 2B	S MO 3B	S MO 4B
Part number	1390640	1390641	1390642
SMPO versions	SMPO 2B	SMPO 3B	SMPO 4B
Part number	1390680	1390681	1390682
Number of beams	2	3	4
Beams spacing (mm)	500	400	300
Protect. height (mm)	510	810	910
Overall height with lamp (mm)	710	1010	1110

Note: Overall height of versions without lamp (S, S TRX, SM, SM TRX) is 25 mm lower than indicated in the tables.

2, 3, 4 beams TRX

S TRX versions	S 2B TRX	S 3B TRX	S 4B TRX
Part number	1390610	1390611	1390612
S TRX - A versions	S 2B TRX - A	S 3B TRX - A	S 4B TRX - A
Part number	1390616	1390617	1390618
SM TRX versions	SM 2B TRX	SM 3B TRX	SM 4B TRX
Part number	1390630	1390631	1390632
S MO TRX versions	S MO 2B TRX	S MO 3B TRX	S MO 4B TRX
Part number	1390650	1390651	1390652
SMPO TRX versions	SMPO 2B TRX	SMPO 3B TRX	SMPO 4B TRX
Part number	1390690	1390691	1390692
Number of beams	2	3	4
Beams spacing (mm)	500	400	300
Protect. height (mm)	510	810	910
Overall height with lamp (mm)	699	970	1070

2, 3, 4 beams LR / LR ILP*

S LR versions	S 2B LR	S 3B LR	S 4B LR
Part number	1390013	1390014	1390015
S LR ILP versions	S 2B LR ILP	S 3B LR ILP	S 4B LR ILP
Part number	1390033	1390034	1390035
SO LR versions	SO 2B LR	SO 3B LR	SO 4B LR
Part number	1390016	1390017	1390018
SO LR ILP versions	SO 2B LR ILP	SO 3B LR ILP	SO 4B LR ILP
Part number	1390036	1390037	1390038
Number of beams	2	3	4
Beams spacing (mm)	500	400	300
Protect. height (mm)	510	810	910
Overall height with lamp LR / LR ILP (mm)	673 / 698	973 / 998	1073 / 1098

ILP: Integrated laser pointer.

ADMIRAL

LONG RANGE AND BLANKING VERSIONS

ADMIRAL AX LR / LR DB

LONG RANGE AND LONG RANGE DUAL-BEAM



Admiral Long Range including a special version featuring an innovative Dual-Beam System. Ideal for outdoor applications as it decreases the sensitivity of the light curtain from small objects that could accidentally interrupt the beams, i.e. birds or leaves but also heavy rain or snow.

- AX LR versions - Max. range: selectable 22 or 60 m
- AX LR DB versions - Max. range: selectable 25 or 80 m



2, 3, 4 beams

	AX 2B LR	AX 3B LR	AX 4B LR	AX 2B LR DB	AX 3B LR DB	AX 4B LR DB
Part number	1334603	1334604	1334605	1334606	1334607	1334608
Nr. beams	2	3	4	2	3	4
Protected height (mm)	510	810	910	510	810	910
Overall height (mm)	711	1011	1111	771	1072	1172

CABLES NEEDED

Emitter: M12 5-pole (CDx)
Receiver: M12 8-pole (C8Dx)

See page 42

ADMIRAL AX LR WT / LR WTH / LR DB WTH

WITH IP67 WATERTIGHT ENCLOSURE



Heated versions available

The IP67 watertight enclosure allows the light curtains to be used in harsh working environments with exposure to water and steam.

- AX LR WT / WTH models - Max. range: selectable 18 or 50 m
- AX LR DB WTH models - Max. range: selectable 20 or 60 m



2, 3, 4 beams

WT: watertight
WTH: watertight + heated

	AX 2B LR WT	AX 3B LR WT	AX 4B LR WT	AX 2B LR WTH	AX 3B LR WTH	AX 4B LR WTH
Part number	1134603	1134604	1134605	1139603	1139604	1139605
Nr. beams	2	3	4	2	3	4
Protected height (mm)	510	810	910	510	810	910
Overall height (mm)	841	1141	1241	841	1141	1241

	AX 2B LR DB WTH	AX 3B LR DB WTH	AX 4B LR DB WTH
Part number	1139606	1139607	1139645
Nr. beams	2	3	4
Protected height (mm)	510	810	910
Overall height (mm)	902	1202	1302

Wiring Supplied with pre-wired 10 m cable

ADMIRAL AX BK

WITH BLANKING FUNCTION

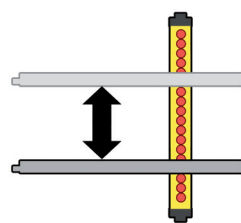

Built-in floating blanking function with 5 configuration options. Floating Blanking allows the detected object to move freely inside the light curtain's protected field, under the condition that the intercepted beams are adjacent and that their number is not higher than the configured one. The ideal light curtain for protecting press brakes, automatic machines and robotised areas, where

the material being processed or moving parts of the machine cross the field protected by the light curtain.

- Start/Restart interlock and EDM via external SR ONE interface
- Protected heights: 160 mm ... 2160 mm
- Max. range: 18 m

Part numbers available on reersafety.com

CABLES NEEDED

Emitter: M12 5-pole (CDx)
Receiver: M12 8-pole (C8Dx)

See page 42





MOSAIC

MODULAR SAFETY
INTEGRATED CONTROLLER



MOSAIC

[1100xxx] with screw terminal
[1100xxx] with clamp terminal

Compatibility

Mosaic M1
Not compatible with the following expansion units:
MA2, MA4, MI8O4, MO4L
Mosaic M1S and Mosaic M1S COM
Compatible with all expansion units

MOSAIC M1 [1100000] [1100002] Standard Master Unit

8 digital inputs
2 inputs for Start/Restart interlock and EDM
2 pairs OSSD safety outputs (PNP 400 mA)
2 status outputs (PNP 100 mA)
4 test outputs (for short-circuit monitoring)
Field-bus interface with MBx modules



Connect up to 14 expansions.....

Additional inputs



Additional outputs



Additional I/Os



Additional status outputs



MIx / MI12 T8 / MAX

Input expansion units

MI8 [1100020] [1100120]
8 digital inputs
4 test outputs (for short-circuit monitoring)
MI16 [1100021] [1100121]
16 digital inputs
4 test outputs (for short-circuit monitoring)
MI12 T8 [1100022] [1100122]
12 digital inputs
8 test outputs (for short-circuit monitoring)
Can manage up to 4 independent safety mats/edges
MA2 [1100026] [1100126]
MA4 [1100025] [1100125]
2 (MA2) or 4 (MA4) independent isolated analogue channels (500 V)
Each channel can detect a 4-20 mA current or a 0-10 V voltage (selectable via MSD software)
Each channel can supply 24VDC up to 30 mA

MOx / MO4L HC S8 / MO4L

Output expansion units

MO2 [1100030] [1100130]
2 pairs OSSD safety outputs (PNP 400 mA)
2 inputs for Start/Restart interlock and EDM
2 status outputs (PNP 100 mA). *See note 2*
MO4 [1100031] [1100131]
4 pairs OSSD safety outputs (PNP 400 mA)
4 inputs for Start/Restart interlock and EDM
4 status outputs (PNP 100 mA). *See note 2*
MO4L HC S8 POWER [1100032] [1100132]
4 single (or 2 pairs) OSSD safety outputs (PNP 2,0 A for each channel, total current 8 A)
4 inputs for Start/Restart interlock and EDM
8 status outputs (PNP 100 mA). *See note 2*
MO4L [1100012] [1100212]
4 single (or 2 pairs) OSSD safety outputs (PNP 400 mA)
Up to 4 inputs for Start/Restart interlock and EDM. *See note 1*
Up to 4 status outputs (PNP 100 mA). *See note 1 and note 2*



MI8Ox

Input/Output expansion units

MI8O2 [1100010] [1100110]
8 digital inputs
2 inputs for Start/Restart interlock and EDM
2 pairs OSSD safety outputs (PNP 400 mA)
2 status outputs (PNP 100 mA). *See note 2*
4 test outputs (for short-circuit monitoring)
MI8O4 [1100011] [1100111]
8 digital inputs
Up to 4 inputs for Start/Restart interlock and EDM. *See note 1*
4 single (or 2 pairs) OSSD safety outputs (PNP 400 mA)
Up to 4 status outputs (PNP 100 mA). *See note 1 and note 2*
4 test outputs (for short-circuit monitoring)

MOSx

Status output expansion units

MOS8 [1100091] [1100191]
8 status outputs (PNP 100 mA). *See note 2*
MOS16 [1100092] [1100192]
16 status outputs (PNP 100 mA). *See note 2*

Note 1:
The total number of feedback inputs + status outputs must be not greater than 4

ACCESSORIES

MSC [1100061]
Mosaic Safety Communication connector
MCM [1100060]
Mosaic Configuration Memory

MTBC-Y [1100046]
6 x clamp terminal blocks
MTB-Y [1100044]
6 x screw terminal blocks
HM1 [1100090]
Display Unit

CSU [1100062]
USB-A configuration cable
Mosaic M1 Standard Master
CSU-C [1100039]
USB-C configuration cable
Mosaic M1S Enhanced Master

MC10 [1100113] - 10 m
MC25 [1100063] - 25 m
MC50 [11 00064] - 50 m
MC100 [1100065] - 100 m
Serial cable for MSC bus

Note 2:
Safety Level:
SIL 1 - SILCL1 PL c

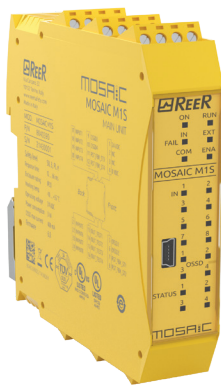

MOSAIC M1S
[1100003] [1100004]

Enhanced Master Unit

- 8 digital inputs
- Up to 4 inputs for Start/Restart interlock and EDM. *See note 1*
- 4 single (or 2 pairs) OSSD safety outputs (PNP 400 mA)
- Up to 4 status outputs (PNP 100 mA). *See note 2*
- 4 test outputs (for short-circuit monitoring)
- Field-bus interface with MBx modules



MOSAIC M1S COM
[1100006] [1100007]

Enhanced Field-bus Ready Master Unit

- 8 digital inputs
- Up to 4 inputs for Start/Restart interlock and EDM. *See note 1*
- 4 single (or 2 pairs) OSSD safety outputs (PNP 400 mA)
- Up to 4 status outputs (PNP 100 mA). *See note 2*
- 4 test outputs (for short-circuit monitoring)
- Integrated Ethernet field-bus interface. Protocols: Ethernet IP, EtherCAT, PROFINET, Modbus TCP
- Remote connectivity

.....to the Master Units

Safety relays



MOR4/MOR4 S8/MRx

Safety relay output expansion units

- MR2** [1100040] [1100140]
2 safety relays with guided contacts
2 NO + 1 NC contacts (250 VAC 6 A)
1 NC contacts for EDM feedback
- MR4** [1100041] [1100141]
4 safety relays with guided contacts
4 NO + 2 NC contacts (250 VAC 6 A)
2 NC contacts for EDM feedback
- MR8** [1100049] [1100149]
8 safety relays with guided contacts
8 NO + 4 NC contacts (250 VAC 6 A)
4 NC contacts for EDM feedback
- MOR4** [1100042] [1100142]
4 safety relays with guided contacts
4 NO contacts (250 VAC 6 A)
It is possible to select two different configurations via MSD:
- 4 independent single channel outputs
- 2 dual channel outputs
4 inputs for Start/Restart interlock and EDM
Individual channel LED signaling
- MOR4 S8** [1100043] [1100143]
As MOR4, with 8 status outputs (PNP 100 mA)

Speed monitoring



MVx

Speed monitoring expansion units

- Safety speed monitoring units (up to PL e).
Can control zero speed, maximum speed, speed range and direction
- MV0** [1100077] [1100177]
Inputs for 2 proximity switches
- MV1**
Inputs for 1 incremental encoder and 2 proximity switches:
- **MV1T** [1100070] [1100170] - TTL
- **MV1TB** [1100086] [1100186] - TTL 24 VDC
- **MV1H** [1100071] [1100171] - HTL
- **MV1S** [1100072] [1100172] - SIN/COS
- MV2**
Inputs for 2 incremental encoders and 2 proximity switches:
- **MV2T** [1100073] [1100173] - TTL
- **MV2TB** [1100087] [1100187] - TTL 24 VDC
- **MV2H** [1100074] [1100174] - HTL
- **MV2S** [1100076] [1100176] - SIN/COS
- MCCV 15P 3F 1.0 m** [1100069]
Sniffer cable (splitter D-Sub 15-pole/RJ45)
- MCCV 15P 3F 1.4 m** [1100067]
Sniffer cable (splitter D-Sub 15-pole/RJ45)
- MCCV 15P 3F 1.8 m** [1100048]
Sniffer cable (splitter D-Sub 15-pole/RJ45)
- MCCV 25P 2F 2.5 m** [1100068]
Sniffer cable (splitter D-Sub 25-pole/RJ45)

Communication



INDUSTRY
4.0
ready

MBx

Field-bus

- MBP** [1100050] [1100150]
Profibus DP
- MBD** [1100051] [1100151]
DeviceNET
- MBC** [1100052] [1100152]
CANopen
- MBEC** [1100053] [1100153]
EtherCAT
- MBEI** [1100054] [1100154]
EthernetIP
- MBEP** [1100055] [1100155]
Profinet
- MBU** [1100056] [1100156]
USB
- MBCC** [1100059] [1100159]
CC-Link
- MBMR** [1100082] [1100182]
Modbus RTU
- MBEM** [1100083] [1100183]
Modbus TCP

MCT

Remote interface units

- Interface unit allowing the connection of remote expansions via proprietary MSC bus
- MCT1** [1100058] [1100158]
1 connection interface (1 I/O)
- MCT2** [1100057] [1100157]
2 connections interface (2 I/O)

CE TUV SUD LISTED IND.CONT.EQ. 4HY4 UL LISTED SRCD 4VK5 S RoHS Compliant EN 8120/50 SAFETY LEVEL SIL 3 SIL3 - SILCL 3 PL e - Cat. 4

MODULAR SAFETY INTEGRATED CONTROLLER

Mosaic is a configurable safety hub able to manage all safety functions of a machinery or a plant. Configurable and scalable, allows costs reduction and minimal wiring.

Mosaic can manage safety sensors and devices such as: light curtains, photocells, laser scanners, emergency stops, electromechanical switches, guard-lock door switches, magnetic switches, RFID switches, inductive sensors, mats and edges, two-hand controls, hand grip switches, encoders / proximities for safety speed control and analogue sensors (i.e. loading cells, pressure switches, temperature measurement, flow and level measurement, etc.).



Watch the video!



Master Unit: Mosaic M1 (Standard) or Mosaic M1S (Enhanced) or Mosaic M1S COM (Enhanced field-bus ready)
The Master Units can be used as a stand-alone device or to control other expansion units

MVx
Expansion units for safety speed monitoring

MOR4
Safety relay units with configurable outputs

MBx
Expansion units for connection to the most common industrial Fieldbus systems for diagnostics and data communication

Field-bus ready
LAN (RJ45) connectors (Mosaic M1S COM only)

ADVANTAGES

- Reducing the number of devices and wiring used and, therefore, the overall size of the project
- Speeding-up control panel construction
- Allow tamper-proof system configurations
- All logic is configured through a graphic interface. No more laborious wiring is needed as with traditional solutions
- A lower number of electromechanical components also means a better Performance Level and, therefore, a higher Safety Level
- The project report provides the actual values of PFH_D , DC_{avg} and $MTTF_D$ according to EN 13849-1 and EN 62061
- Remote connectivity (Mosaic M1S COM only)



MAx
Analogue inputs expansion unit

MSC Mosaic Safety Communication connector
Allows communication between the various units through a proprietary high-speed safety bus

Removable terminals
MTBC
Clamp terminal blocks
MTB
Screw terminal blocks

Configuration via USB
USB 2.0 serial bus for the connection to the Mosaic Safety Designer software (MSD)

MCM Mosaic Configuration Memory
Removable memory card for saving Mosaic configuration data for subsequent transfers to a new device (without using a PC) or for backup

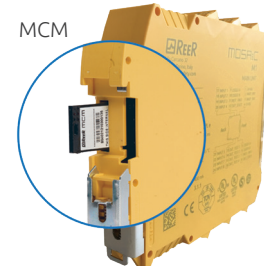
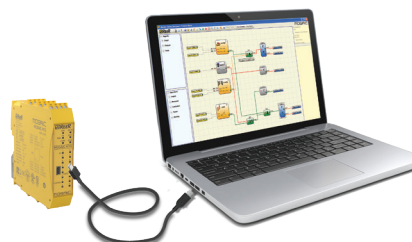
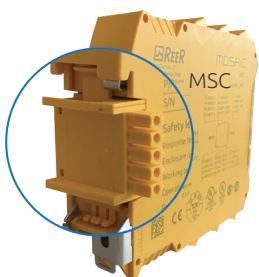

MOSAIC SAFETY DESIGNER

Mosaic M1, Mosaic M1S and Mosaic M1S COM Master Units come with a complementary copy of the MSD designer software. The modules configuration is done via a USB connection.

The Drag & Drop functionality allows to easily create all logic scenarios in a machine directive compliant environment.



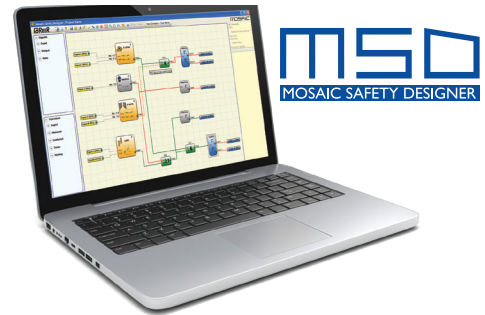



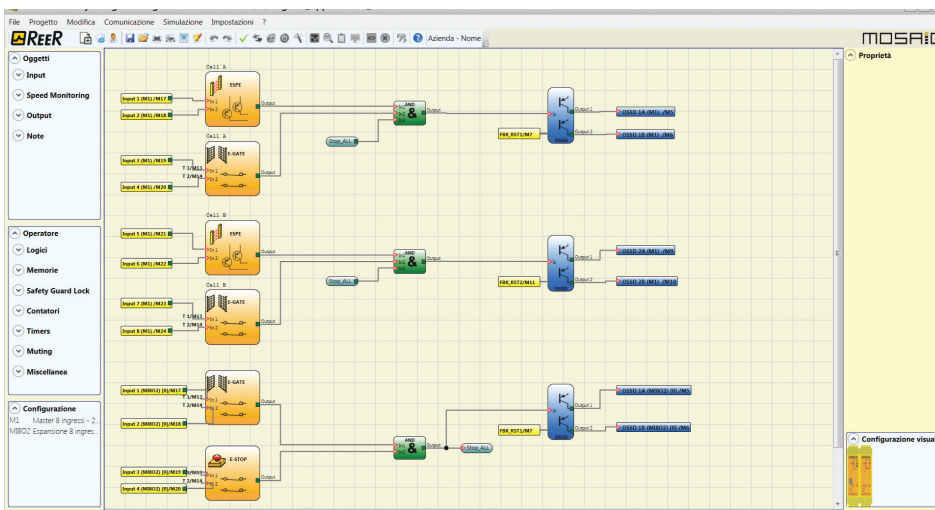

Now with remote connection (Mosaic M1S COM master unit).





 Download the MSD software from:
www.reersafety.com/download/mosaic



-  Drag & Drop functionality
-  User-friendly
-  Project information
-  Built-in simulator
-  Design validation
-  Security 2-level password
-  Reports and log files
-  Real-time monitor

BUILT-IN SIMULATOR

REAL-TIME MONITOR

FIELD-BUS PARAMETER CONFIGURATION

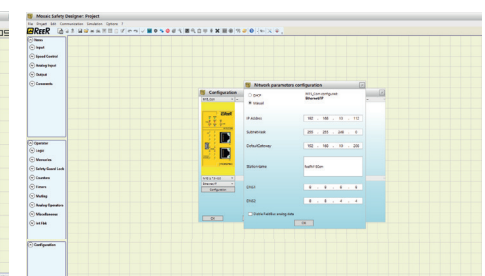
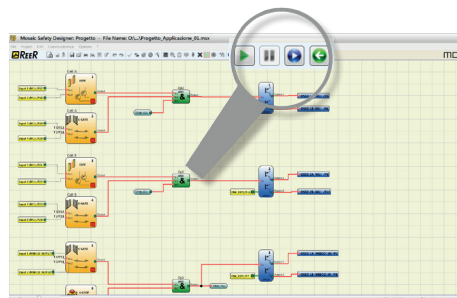
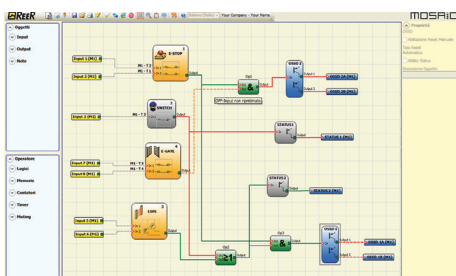

MCT
Remote Interface Units



Interface module allowing the connection of remote expansion units via the MSC safety bus

Mosaic M1S COM can be connected to field-bus: *ModBus TCP, EtherNet/IP, Profinet RT or EtherCat.*

APPLICATION EXAMPLE

SAFETY MANAGEMENT OF A MACHINING CENTRE WITH ALTERNATE LOAD / UNLOAD

A machining centre operates over two independent bays alternatively. Once the machine is positioned in one bay, this bay is considered dangerous, whilst the other remains accessible to the operator for load/unload operations of workpieces. The hazardous working area is protected by two horizontal safety light curtains. In this case, each light curtain must be equipped with the Muting function so as to permit access to the working area by personnel during the non-hazardous phase of the machine cycle. The Muting condition of the two safety light curtains will then be inverted when the tool is required to operate on the opposite side of the machine. The remaining sides of the machine are completely protected by fences with an access gate equipped with a safety switch. If the gate is opened, the machine stops. A manual restart control is located close to each safety light curtain. The system is equipped with three emergency stops that, if activated, shall stop the machine.

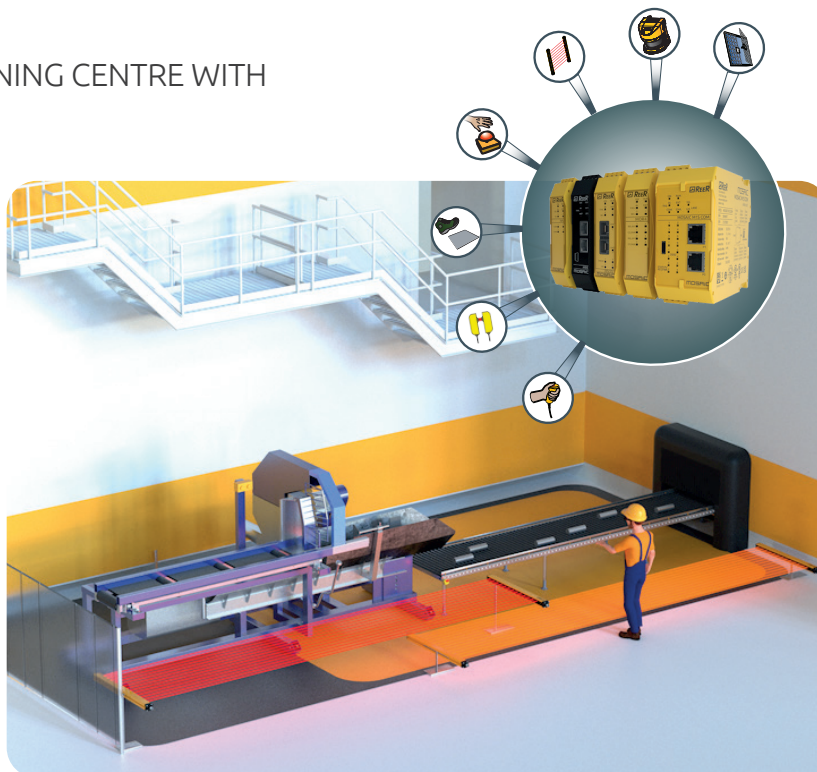

Total safety components: 2 safety light curtains, 2 restart buttons for the safety light curtains, 1 safety gate switch, 3 emergency stops. If using conventional safety relay modules to build up the safety circuit, a total of four safety relays would be necessary: 2 safety relays for the safety light curtains with Muting function, 1 safety relay for the gate switch, 1 safety relay for the emergency stops (connected in series).

THE MOSAIC SOLUTION

For a correct configuration with Mosaic, a total of two units must be used:

- Mosaic Master Unit
- MI8 Expansion Unit

NOTE: the Reset buttons are not displayed on the diagram because they are directly connected to the feedback of the OSSD safety outputs (inputs FBK_RST1, FBK_RST2).

The 3 e-stops are connected in series and are represented in the diagram with a single block.

The diagram also shows 2 status outputs used to drive the indication lights of the active Muting.

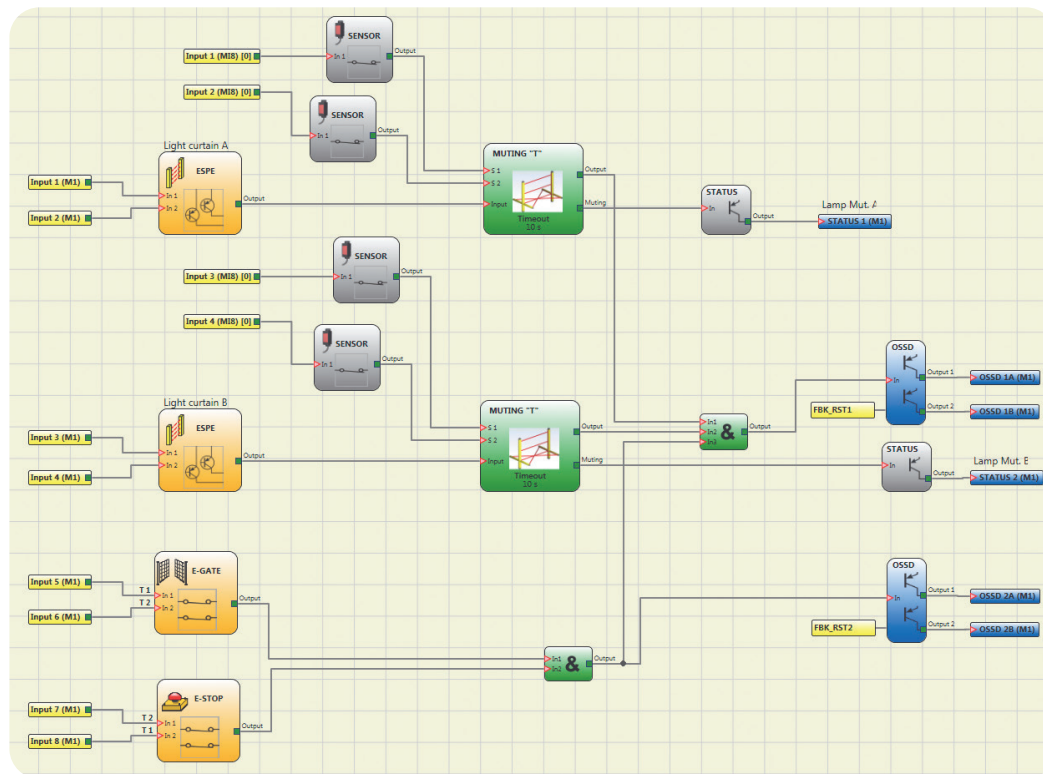

System capabilities: 16 inputs - 2 OSSD pairs - 8 test outputs - 2 signal outputs



MZERO

STAND-ALONE SAFETY
CONTROLLER

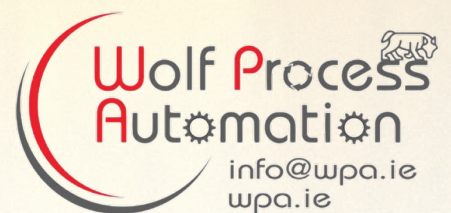

MZERO

STAND-ALONE SAFETY INTEGRATED CONTROLLER

MZERO is a configurable safety hub able to manage all safety functions of a machinery or a plant. Allows cost reductions and minimal wiring.

MZERO can manage safety sensors and signals such as light curtains, photocells, laser scanners, emergency stops, electromechanical switches, guard-lock door switches, magnetic switches, RFID switches, inductive sensors, mats and edges, two-hand controls and hand grip switches.

Configuration via USB
USB 2.0 serial bus for the connection to the MZERO Safety Designer software (MZD)

Removable terminals
MTBC Clamp terminal blocks
MTB Screw terminal blocks

4 inputs for Start/Restart interlock, EDM or single input devices

16 safety inputs

64 logical operators

4 pairs OSSD safety outputs (PNP 400 mA)

4 test outputs (for short-circuit monitoring)

4 SIL 1/PL c status outputs (PNP 100 mA)

SAFETY LEVEL
SIL 3
SIL3 - SILCL 3
PL e - Cat. 4

CE, UK CA, UL US LISTED IND. CONTEQ. 4HY4, UL LISTED SRC'D 4VK5, TÜV SÜD, RoHS Compliant, and other certification logos.

PART NUMBERS

MZERO 16.4 [1100005] with screw terminal block
MZERO 16.4 C [1100205] with clamp terminal block

MZERO SAFETY DESIGNER

Easy-to-use designer software included with the MZERO unit. Includes all the features and options of MSD (Mosaic Safety designer) software.

MZD
MZERO SAFETY DESIGNER

Download the MSD software from:
www.reersafety.com/download/mosaic

ADDITIONAL SAFETY RELAY OUTPUT MODULES

MR2 [1100040] [1100140] 2 safety relays with guided contacts 2 NO + 1 NC contacts (250 VAC 6 A) 1 NC contacts for EDM feedback	MR4 [1100041] [1100141] 4 safety relays with guided contacts 4 NO + 2 NC contacts (250 VAC 6 A) 2 NC contacts for EDM feedback	MR8 [1100049] [1100149] 8 safety relays with guided contacts 8 NO + 4 NC contacts (250 VAC 6 A) 4 NC contacts for EDM feedback
--	--	--

ADVANTAGES

- Bringing full configuration capabilities at the cost of a standard safety relay
- Reducing the number of devices and wiring used and, therefore, the overall size of the project
- Speeding-up control panel construction
- Allow tamper-proof system configurations
- All logic is configured through a graphic interface. No more laborious wiring is needed as with traditional solutions
- A lower number of electromechanical components also means a better Performance Level and, therefore, a higher Safety Level
- The project report provides the actual values of PFH_D, DC_{avg} and MTTF_D according to EN 13849-1 and EN 62061



SAFETY INTERFACES

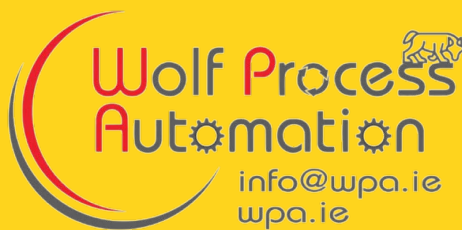

SR SELECT

MULTIFUNCTION SAFETY INTERFACE



The new SR SELECT allows four different operating modes offering the possibility to connect and control different types of safety devices, including: Safety Light Curtains, Solid-State-Output Devices (i.e. RFID safety switches), Dual-Channel Emergency Stops, Two-Hand Controls and Type 2 Safety Photocells.

- Different safety functions selectable via rotary switch
- Selectable manual or automatic restart
- 2 N.O. outputs with guided contact safety relays
- 1 system monitor PNP output
- 1 external contactors feedback input
- 1 system test input (for Type 2 light curtains)

PART NUMBER

SR SELECT [1330941] with screw terminal
SR SELECT C [1330813] with clamp terminal



TECHNICAL CHARACTERISTICS

Power supply (VDC)	24 ± 20%
Power requirement (W)	5 max.
Relay output	2 NA - 6A; 250 Vca
System status output	PNP - 100 mA; 24 Vcc
Response time (ms)	≤ 20
Operating modes	Automatic, Monitored or Manual (selectable via rotary switch)
External relay control EDM	Series of contacts NC (20 mA; 24 VDC)
Connections	Terminal block with protection against reversal of polarity
LED status indicators	Input - Output - Fail
Length of connections (m)	100 Max.
Operating temperature (°C)	-30 ... +55
Protection rating	Enclosure IP 20 Terminal block IP 2X
Fastening	Fast attachment to rail according to EN 50022-35
Dimensions (h x w x d) (mm)	99 x 22,5 x 114,5
Weight (g)	150
B10d	800.000
Device lifetime (years)	20

OPERATING MODES

- Type 4 interface for OSSD output devices
- Safety relay for emergency stop and safety switches.
- Safety relay for two-hand control
- Type 2 control unit for safety photocells

Selectable via the Rotary Switch.

Rotary Switch position	Operating mode	Operating function
0	Prog.	Programming mode start
1	1A	OSSD double input, automatic restart mode
2	1C	OSSD double input, monitored restart mode
3	2A	Gate monitoring/Emergency stop function, automatic restart mode
4	2M	Gate monitoring/Emergency stop function, manual restart mode (not monitored)
5	2C	Gate monitoring/Emergency stop function, monitored restart mode
6	3A	Two-hand control 2 NO contacts, automatic restart mode
7	3C	Two-hand control changeover contact, monitored restart mode
8	4A	Type 2 photocells control, automatic restart mode
9	4C	Type 2 photocells control, monitored restart mode

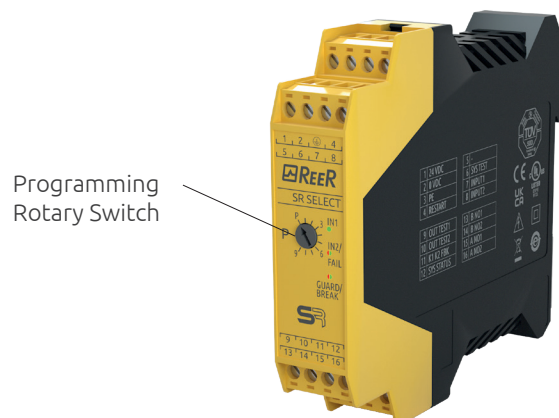



SAFETY INTERFACES

<p>SAFETY INTERFACES</p> <p>SAFETY LEVEL</p> <p>SIL 3</p> <p>SIL3 - SILCL 3 PL e - Cat. 4</p> <p>CE UK CA TUV SUD cUL LISTED</p> <p>Power Supply (VDC) Safety relay output Response time (ms) Dimensions h x w x d (mm)</p>	<p>SR ZERO [1330801] - SR ZERO A [1330802] SR ZERO C [1330806] - SR ZERO A C [1330807] FOR DEVICES WITH INTEGRATED EDM</p> <p>Guided-contact safety relays. Can only be connected to safety sensors equipped with feedback input for monitoring external relays (EDM). Additional NC contact line for the monitoring by light curtain EDM (input and output).</p> <p>24 ± 20% SR ZERO: 2 NO + 1 NC (2 A, 250 VAC) SR ZERO A: 2 NO (2 A, 250 VAC) ≤ 20 99 x 22,5 x 114,5</p>	<p>SR T [1330805] SR T C [1330810] FOR TWO-HAND CONTROLS</p> <p>Guided-contact safety relays. Input with 3 or 4 contacts for two-hand control unit. Certified as Type III C according to the EN 574 standard, monitors the simultaneity between the two inputs (< 0.5 sec). EDM feedback input.</p> <p>24 ± 20% 2 NO (6 A 240 VAC / 24 VDC) ≤ 30 99 x 22,5 x 114,5</p> <p>SAFETY LEVEL</p> <p>PL e</p> <p>Cat. 4 Type III C (EN 574)</p>
<p>TYPE 4 INTERFACES FOR OSSD OUTPUT SAFETY DEVICES</p> <p>SAFETY LEVEL</p> <p>TYPE 4</p> <p>SILCL 3 PL e - Cat. 4</p> <p>CE UK CA TUV SUD cUL LISTED</p> <p>Power Supply (VDC) Safety relay output Status output Response time (ms) Dimensions h x w x d (mm)</p>	<p>SR ONE [1330900] - SR ONE C [1330811]</p> <p>Guided-contact safety relays. Manual or automatic Start/Restart. EDM feedback input.</p> <p>24 ± 20% 2 NO - 6 A 250 VAC PNP - 100 mA at 24 VDC ≤ 20 99 x 22,5 x 114</p>	<p>SR ONE M [1330904] - SR ONE M C [1330812] WITH INTEGRATED MUTING FUNCTIONS</p> <p>Guided-contact safety relays. Sensor logic integrated Muting (0 or 24 VDC - PNP or relay - dark-on). Input for Muting enable (0 or 24 VDC - PNP or relay). Muting Time-out: 30 sec. or infinite. Override (max. 15 min.).</p> <p>24 ± 20% 2 NO - 6 A 250 VAC PNP - 100 mA at 24 VDC ≤ 20 99 x 35 x 114</p>
<p>INTERFACES FOR EMERGENCY STOP BUTTONS AND SAFETY SWITCHES</p> <p>SAFETY LEVEL</p> <p>PL e</p> <p>SIL 3 - SILCL 3 Cat. 4</p> <p>CE UK CA TUV SUD cUL LISTED</p> <p>Power Supply (VDC) Safety relay output Response time (ms) Dimensions h x w x d (mm)</p>	<p>SR E4 [1330803] - SR E4 C [1330808]</p> <p>Guided-contact safety relays. Manual or automatic Start/Restart. EDM feedback input.</p> <p>24 ± 10% 2 NO (6 A 240 VAC / 24 VDC) ≤ 20 99 x 22,5 x 114</p>	<p>SR E4C [1330804] - SR E4C C [1330809]</p> <p>Guided-contact safety relays. Manual monitored Start/Restart. EDM feedback input.</p> <p>24 ± 10% 2 NO (6 A 240 VAC / 24 VDC) ≤ 20 99 x 22,5 x 114</p>
<p>INTERFACES FOR SAFETY ILION AND ULISSE PHOTOCELLS</p> <p>SAFETY LEVEL</p> <p>TYPE 2</p> <p>SILCL 1 PL c - Cat. 2</p> <p>CE UK CA TUV SUD cUL LISTED</p> <p>Power Supply (VDC) Safety relay output Response time (ms) Dimensions h x w x d (mm)</p>	<p>SR X [1201710] - SR X C [1201714]</p> <p>Guided-contact safety relays. Self test every 5 sec. Manual or automatic Start/Restart. EDM feedback input.</p> <p>24 ± 20% 2 NO - 6 A 250 VAC ≤ 30 99 x 22,5 x 114</p>	<p>SR X M [1201711] - SR X M C [1201715] WITH INTEGRATED MUTING FUNCTIONS</p> <p>Guided-contact safety relays. Sensor logic integrated Muting (0 or 24 VDC - PNP or relay - dark-on). Input for Muting enable (0 or 24 VDC - PNP or relay). Muting Time-out: 30 sec. or infinite. Override (max. 15 min.).</p> <p>24 ± 20% 2 NO - 6 A 250 VAC ≤ 30 99 x 35 x 114</p>

Note: C version with clamp terminals



R-SAFE



SAFETY DEVICES

R-SAFE RFID

PI-SAFE

MAGNUS MG

ILION - ULISSE

CONTACTLESS RFID SAFETY SWITCH



Models

- R-Safe RFID Plus (with M12 8 poles)
- R-Safe RFID Basic (with M12 5 poles)

Safety switches for position control of movable guards.

- RFID technology
- 22 mm interaxis
- IP67 e IP69K protection degree
- Three types of connection: M12 connector, M12 connector with Pigtail, cable
- Series connection with status information (with Mosaic M1S Enhanced)
- Highly visible status LED
- Anti-tampering protection caps

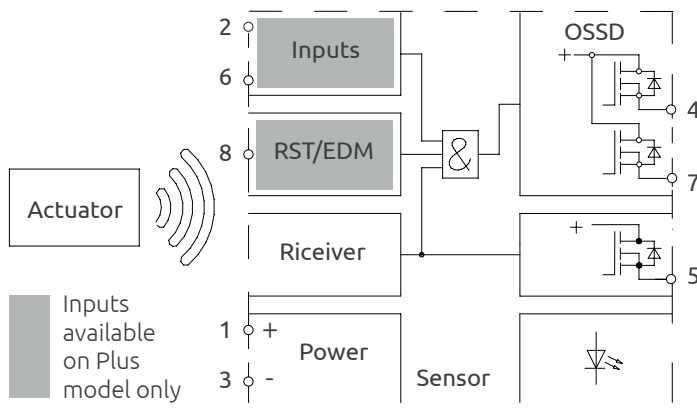

Approvals and safety characteristics

PL e
Category 4
PFHd 3,58E-9
SFF 90% ... 99%
SIL 3

ISO 13849-1
ISO 13849-1
IEC 61508-1
IEC 61508-1
IEC 61508-1



TECHNICAL CHARACTERISTICS

Electrical specifications

Supply voltage (VDC)	24 ± 20%
Power consumption (W)	0,5
Switching current safety output (mA)	Max. 300
Switching current status output (mA)	Max. 100
Safety outputs	2 OSSD active high
Safety inputs	2 inputs active high
Status output	1 output active high
Restart	Monitored normally open Restart input in series with EDM

Operating characteristics

Functioning operating distance (mm)	12 mm
Assured release distance - Sar (mm)	25 mm
Operating temperature (°C)	-25 ... +70
Storage temperature (°C)	-25 ... +70
Humidity	0% @ 70 °C ... 90% @ 20 °C
Protection class	IP65/IP67 (IP69K version with cable)
Shock resistance	30g / 11ms IEC 60068
Vibration resistance	10 ... 55 Hz, amplitude 1 mm
Switch-on delay (s)	10 typical, 15 max.
Standalone Risk time (ms)	Δ Rt ≤ 55
Operating direction	Any direction
Switching principle	Electronic
Series connection	Max. 16 sensors
Technology	RFID

Mechanical data

Material	Polyketone (POK)
Housing	Rectangular
Connector type	M12 8 or 5 poles
Cable	PVC 8 or 5 wires
Cross-section of wire (mm²)	0,25
Temp. range cable (°C)	-25 ... 80
Dimensions h x w x d (mm)	28,5 x 57 x 18
Mounting type	M4 screws (countersunk)

Multiple options of actuation technology

Generic coding (low level coding)

The actuator is free and not specifically assigned to the sensor (one actuator can work with multiple generic sensors)

Teach-in coding (high level coding Plus model only)

The actuator is programmed via teach-in and permanently assigned to the sensor during set-up (the process can be repeated if necessary)

Unique coding (high level coding)

The actuator is permanently assigned to the sensor during manufacturing (it cannot be replaced with another actuator)

Watch the video!



CONTACTLESS RFID SAFETY SWITCH

SERIES CONNECTION

Up to PL e
Performance Level according to EN ISO 13849-1



MOSAIC or PLC or safety interfaces

OSSD + Status

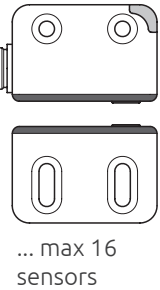
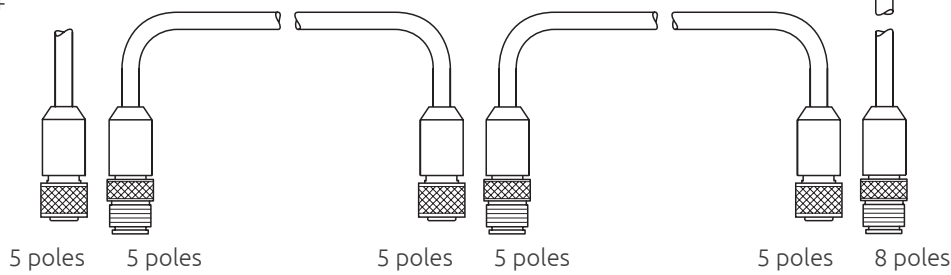

Splitter connector S2

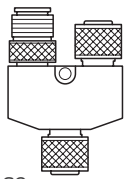

Splitter connector S2

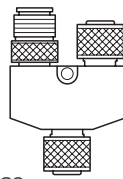

Splitter connector S1

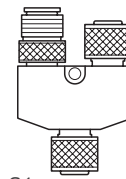

Splitter connectors (for series connection)

CRY12-885 [1295106]
TYPE S1 connector, for the last sensor of the serie

CRY12-855 [1295107]
TYPE S2 connector, for all sensors of the series (escl. last)

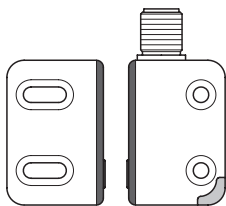

1st RFID sensor

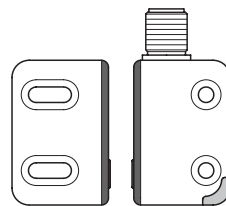

2th RFID sensor

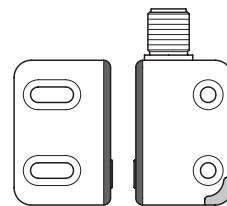

3rd RFID sensor

EXAMPLE OF CONNECTION WITH MOSAIC

Allows individual status reading without individual status output wiring

The signal status contains the individual status of each sensor in the series.

A simple logic signal readable by any PLC or directly with Mosaic M1S or Mosaic M1S COM.

The status of each single sensor is also available on fieldbus data information.

OSSD outputs from the first sensor of the series

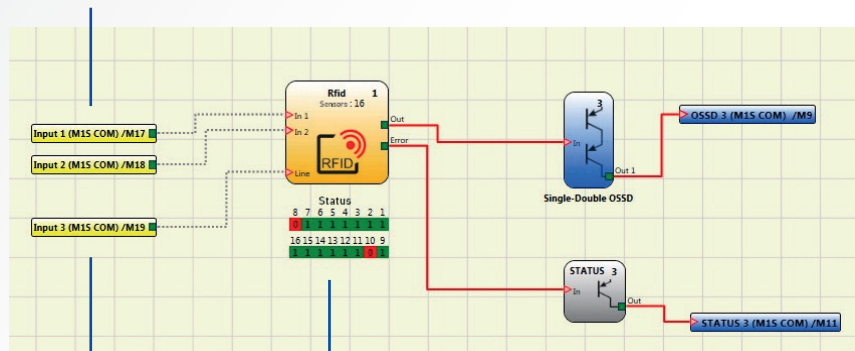

Status output from first sensor of the series

Status of each single sensor

CONTACTLESS RFID SAFETY SWITCH

PART NUMBERS

Combo¹ (Sensor + Actuator)

Model	Part number	Connection	Coding	Operative modes
RRFID PLUS C S G 1	1295047	Cable 1 m	Generic coding	
RRFID PLUS C S G 3	1295057	Cable 3 m		
RRFID PLUS C S G 5	1295000	Cable 5 m		
RRFID PLUS C S G X	1294020	Cable 10 m		
RRFID PLUS C S T 1	1295048	Cable 1 m	Teach-In coding	Manual restart
RRFID PLUS C S T 3	1295058	Cable 3 m		
RRFID PLUS C S T 5	1295001	Cable 5 m		
RRFID PLUS C S T X	1294023	Cable 10 m		
RRFID PLUS C S U 1	1295049	Cable 1 m	Unique coding	Automatic restart (without EDM)
RRFID PLUS C S U 3	1295059	Cable 3 m		
RRFID PLUS C S U 5	1295002	Cable 5 m		
RRFID PLUS C S U X	1294026	Cable 10 m		
RRFID PLUS C S G P	1295003	M12 pigtail	Generic coding	Serial connection
RRFID PLUS C S T P	1295004	M12 pigtail	Teach-In coding	
RRFID PLUS C S U P	1295005	M12 pigtail	Unique coding	
RRFID PLUS C S G C	1295006	M12 connector	Generic coding	
RRFID PLUS C S T C	1295007	M12 connector	Teach-In coding	
RRFID PLUS C S U C	1295008	M12 connector	Unique coding	
RRFID BASIC C S G 1	1295050	Cable 1 m	Generic coding	
RRFID BASIC C S G 3	1295060	Cable 3 m		
RRFID BASIC C S G 5	1295010	Cable 5 m		
RRFID BASIC C S G X	1294029	Cable 10 m		
RRFID BASIC C S U 1	1295252	Cable 1 m	Unique coding	Automatic restart
RRFID BASIC C S U 3	1295262	Cable 3 m		
RRFID BASIC C S U 5	1295012	Cable 5 m		
RRFID BASIC C S U X	1294032	Cable 10 m		
RRFID BASIC C S G P	1295013	M12 pigtail	Generic coding	
RRFID BASIC C S U P	1295015	M12 pigtail	Unique coding	
RRFID BASIC C S G C	1295016	M12 connector	Generic coding	
RRFID BASIC C S U C	1295018	M12 connector	Unique coding	

Note 1

Each Combo set is provided with a Sensor and the corresponding Actuator. Sensors and Actuators can be also ordered separately

Sensor

Model	Part number	Connection	Coding	Operative modes
RRFID PLUS S S G 1	1295043	Cable 1 m	Generic coding	Manual restart
RRFID PLUS S S G 3	1295053	Cable 3 m		
RRFID PLUS S S G 5	1294000	Cable 5 m		
RRFID PLUS S S G X	1294010	Cable 10 m		
RRFID PLUS S S T 1	1295044	Cable 1 m	Teach-In coding	Automatic restart
RRFID PLUS S S T 3	1295054	Cable 3 m		
RRFID PLUS S S T 5	1294001	Cable 5 m		
RRFID PLUS S S T X	1294013	Cable 10 m		
RRFID PLUS S S G P	1294003	M12 pigtail	Generic coding	Serial connection
RRFID PLUS S S T P	1294004	M12 pigtail	Teach-In coding	
RRFID PLUS S S G C	1294006	M12 connector	Generic coding	
RRFID PLUS S S T C	1294007	M12 connector	Teach-In coding	
RRFID BASIC S S G 1	1295045	Cable 1 m	Generic coding	Automatic restart
RRFID BASIC S S G 3	1295055	Cable 3 m		
RRFID BASIC S S G 5	1294009	Cable 5 m		
RRFID BASIC S S G X	1294016	Cable 10 m		
RRFID BASIC S S G P	1294012	M12 pigtail		
RRFID BASIC S S G C	1294015	M12 connector		

Actuator

Model	Part number	Coding
RRFID A S G	1294050	Generic coding
RRFID A S T	1294051	Teach-In coding

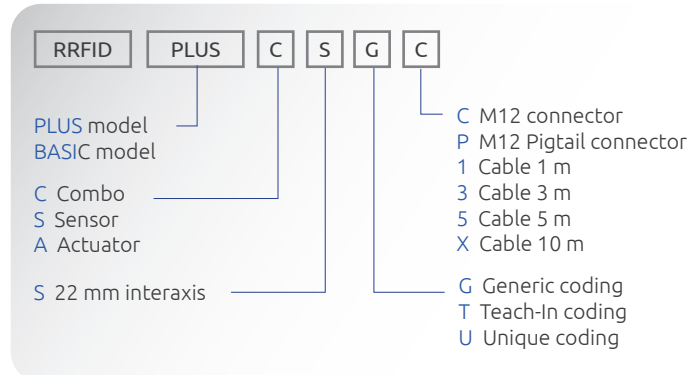

CONNECTION

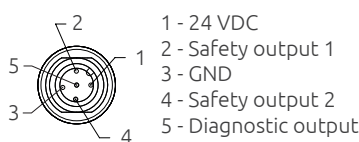

Basic model pin-out

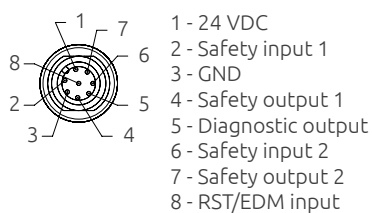

Plus model pin-out

CABLES NEEDED

- Models with M12 connector and M12 Pigtail - Cables CDx and CF8x.
[See page 42.](#)
- Extension cables for series connection - Cable CFM5Px and CFM8Px.
[See page 42.](#)

πS PI-SAFE

PROXIMITY INDUCTIVE SAFETY SENSOR



A complete range of safety switches for position detection. Inductive safety applications are special applications which require a non-contact and safe detection of a metal object.

- Compliant to EN 60947-5-3 for electromechanical control gear
- Ensuring operator and machine safety
- No special actuator for electronic fail-safe sensors required
- Connection to safety interface, safety controller or safety PLC (i.e. SR ONE, Mosaic)

PART NUMBERS

Cylindrical with metal thread

	PI M12 NF	PI M18 NF	PI M30 NF	PI M30 NF K	PI M18 F	PI M18 FR	PI M30 F
Safety level		PL d / SIL 2		PL e / SIL 3	PL d / SIL 2		
Mounting		Non-flush mountable			Flush mountable		
Dimensions (mm)	M12 x 1 L = 70	M18 x 1 L = 70,5	M30 x 1,5 L = 70	M30 x 1,5 L = 80	M18 x 1 L = 70	M18 x 1 L = 86,5	M30 x 1,5 L = 70
Enable zone (mm)	0,5 ... 4	1 ... 8	1 ... 15	6 ... 12	1 ... 5	> 10	6 ... 12
Part number	1293000	1293001	1293004	1293006	1293002	1293003	1293005

Rectangular

	PI SQ F-NF	PI SQ NF
Safety level	PL e / SIL 3	
Mounting	Non-flush or flush mountable	Non-flush mountable
Dimensions (mm)	40x40x66	40x40x66
Enable zone (mm)	10 ... 15	4 ... 20
Part number	1293007	1293008

CONNECTORS

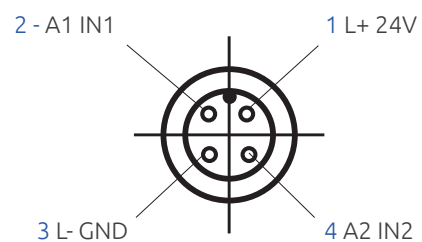

CABLES NEEDED

All models: M12 5-pole See page 42

PROXIMITY INDUCTIVE SAFETY SENSOR

MAIN FEATURES

Operating voltage (VDC)	19,2 ... 30
Switching current (mA)	Max. 100
Safety output	2 OSSD
Electrical design	DC PNP
Connection	M12 4-pole connector
Signalling	LED yellow (signal), LED green (power)
Protection class	III

ACCESSORIES



Angle brackets
 M12 [1293100]
 M18 [1293101]
 M30 [1293102]



Mounting clamps
 M12 [1293103]
 M18 [1293104]
 M30 [1293105]

APPLICATIONS

1. Door or flaps detection at closed position
2. Cylinder shaft detection
3. Treads up detection
4. Cable position detection
5. Equipment position control
6. Robot cell working limitation of the working area
7. Safe position
8. Wind turbine lock / end-position of the blade

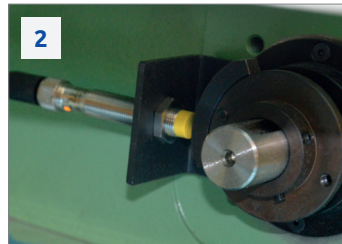

MAGNUS MG

CONTACTLESS MAGNETIC SAFETY SWITCH

- Compact and robust thermoplastic enclosure (PBT)
- Coded magnetic operations, tamper resistant
- Can be connected to the Mosaic safety configurable controller to form a certified PL e safety system
- Sensor with 4 wires: 2 NO contacts.



S SERIES

22 mm interaxis

Operating voltage (VDC)	24
Switching current (mA)	Max. 100
Series resistance (Ohm)	22
Switching power (W)	3
Shock resistance (Hz/g)	10 - 2000/35
Possible actuation magnets	MG S M to be ordered separately



B SERIES

78 mm interaxis

Operating voltage (VDC)	24
Switching current (mA)	Max. 100
Series resistance (Ohm)	22
Switching power (W)	3
Shock resistance (Hz/g)	10 - 2000/35
Possible actuation magnets	MG B M to be ordered separately MG B M+ to be ordered separately (only use reinforced actuation magnets if a gap of more than 4 mm is unavoidable)
Possible actuation reinforced magnets	



M SERIES

Cylindrical housing M20 mounting

Operating voltage (VDC)	24
Switching current (mA)	max. 100
Series resistance (Ohm)	22
Switching power (W)	3
Shock resistance (Hz/g)	10 - 2000/35
Possible actuation magnets	MG M M to be ordered separately MG M M+ to be ordered separately (only use reinforced actuation magnets if a gap of more than 4 mm is unavoidable)
Possible actuation reinforced magnets	

CABLES NEEDED

C8 G3 [1291070] 3m
 C8 G5 [1291072] 5m
 M8 4-pole (Female)

C8 G93 [1291070] 3m
 C8 G95 [1291072] 5m
 M8 4-pole (female) 90° angle connector

ILION & ULISSE

SAFETY PHOTOCELLS

ILION

Type 2 safety photocell with M18 cylindrical metal body

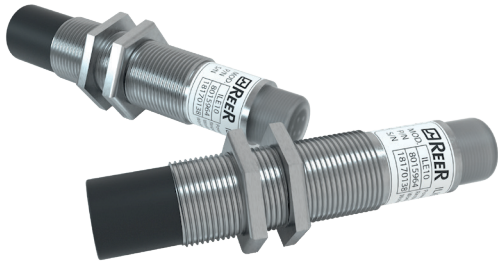

Model	Part number	Characteristics
		Minimum detectable object 12 mm
		Max. range: - 8 m IL 10 - 20 m IL 20
IL 10	1200201	
IL 20	1200202	
		Output: PNP - 100 mA
		Electrical connections: M12 4-pole
		Dimensions: Ø 18 x 85mm

CABLES NEEDED

Models IL 10 and IL 20: M12 5-pole. Pin 5 not connected.

ACCESSORIES

IL FB [1200090]
Set of 2 adjustable brackets

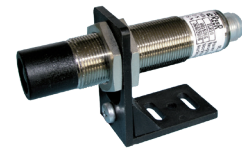

ULISSE

Type 2 safety photocell with metal body and M8 3-pole connector



Model	Part number	Characteristics
		Minimum detectable object: 8 mm
		Max. range: 6 m
UPC	1200300	UPC output: PNP - 100 mA max
UNC	1200302	UNC output: NPN - 100 mA max
		Electrical connections: M8 a 3 poli
		Dimensions: 58 x 15 x 25 mm

CABLES NEEDED

C 85 [1200217] 5m
C 815 [1200219] 15m

EXTERNAL SAFETY INTERFACES

- SR X [1201710] Type 2 control unit. [See page 27](#)
- SR X M [1201711] Type 2 control unit with integrated Muting. [See page 27](#)
- SR SELECT [1330941] Multifunction safety relay with screw terminal - Photocells control program (4) [See page 26](#)
- SR SELECT C [1330813] Multifunction safety relay with clamp terminal - Photocells control program (4) [See page 26](#)



SR X



SR X M



SR Select

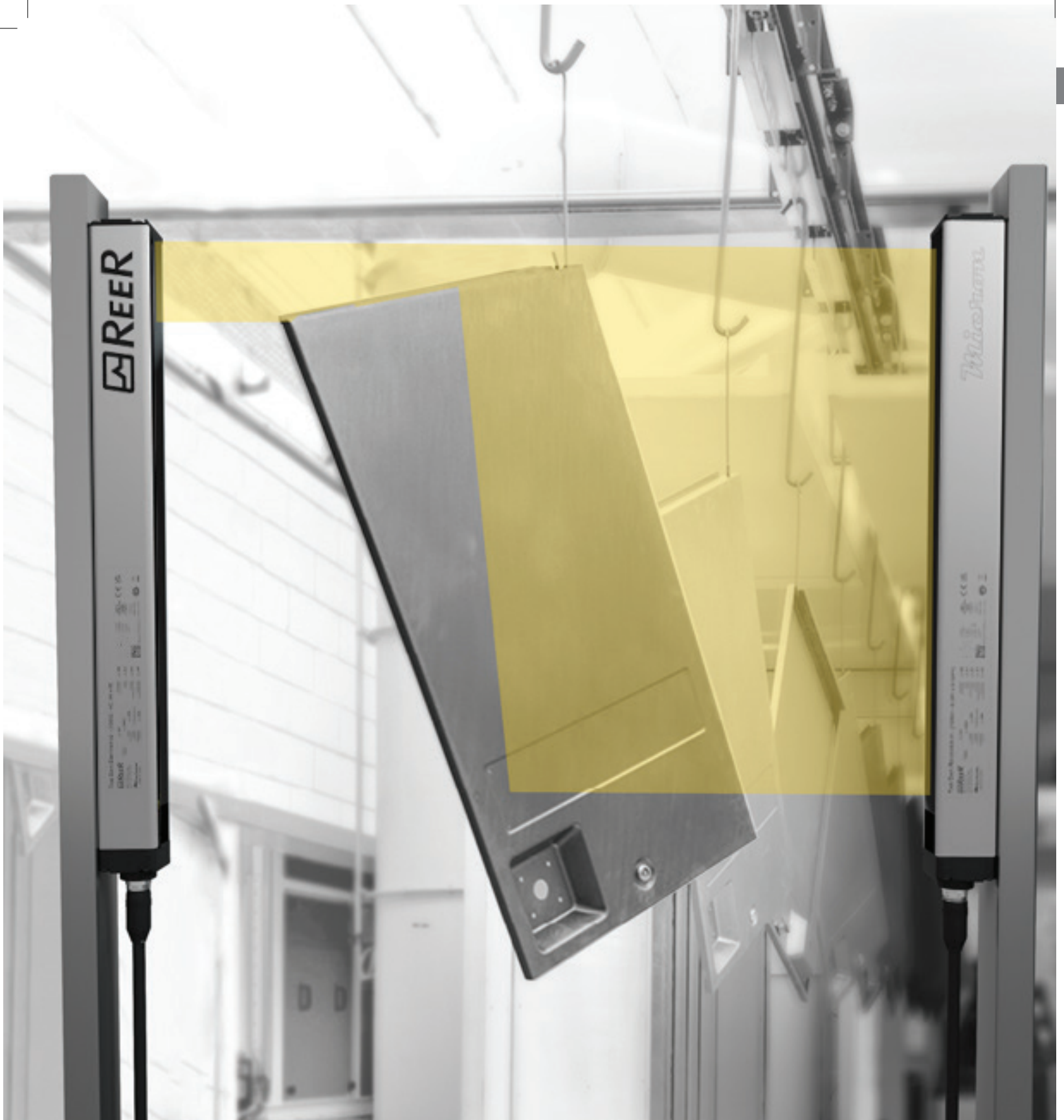

MicroScan
MEASUREMENT AND AUTOMATION
LIGHT CURTAINS

MEASUREMENT AND AUTOMATION LIGHT CURTAINS

Light curtains for industrial and civil applications where it is necessary to detect, measure and recognize objects.

Aluminum casing
Powder-coated



-10 ... +55° C
Operating temperature

Caps
Glass reinforced polypropylene

Compact size
Only 30 x 28 mm

M12 connectors
Cables easy to source and replace

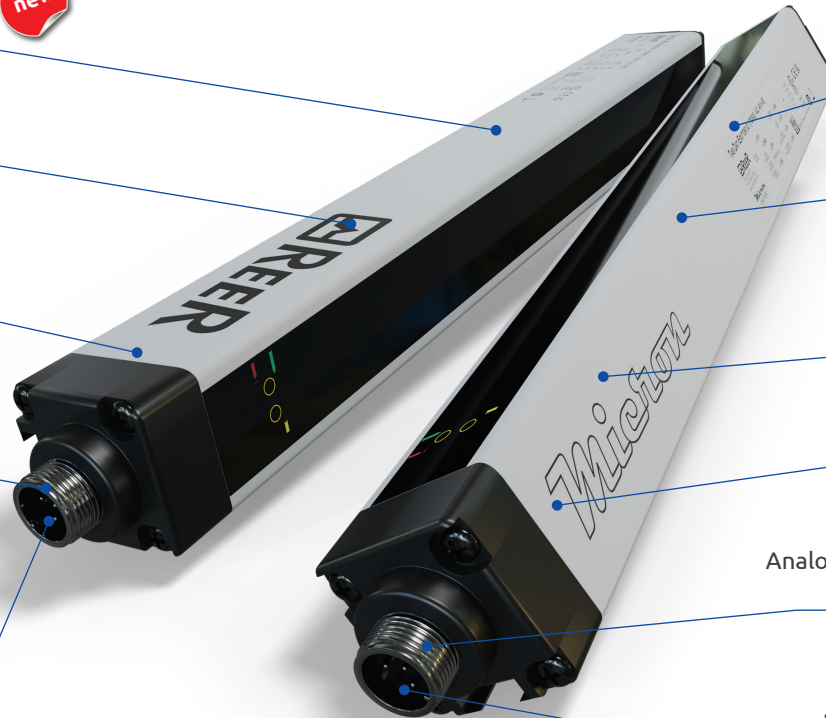

IP65 and IP67

Controlled height
up to 3 meters

Beam spacing
5 mm, 10 mm, 25 mm
30 mm, 50 mm, 75 mm

Status display

Analogue and Digital readings
2 outputs

Software configuration
Easy to use and extensive parameters choice

IO-Link



Versions with IO-Link protocol

- Detect the presence/absence of an object
- Perform a count
- Detect a position
- Detect a shape or profile
- Measure dimensions

Watch the video!



VERSIONS AVAILABLE

MICRON A		MICRON B	MICRON C	MICRON IO-LINK
Versions MI AV	Versions MI AC	Versions MI B	Versions MI C	Versions MI IOL
Ideal for object measurement and detection of dimensional limits		Ideal for dimensional measurement, detection of object profile and position	Ideal for piece counting and detection of object presence/absence in the controlled field	Ideal for dimensional measurement, detection of object profile and position
Two analogue outputs (0-10 VDC) with programmable functions	Two analogue outputs (4-20 mA) with programmable functions	RS 485 serial interface with programmable functions	Two antivalent solid state outputs	IO-Link protocol
Two programmable digital outputs	Two programmable digital outputs	Two programmable digital outputs	-	IO-Link output
Solution providing simple measurement with easy interfacing		Solution providing complete and detailed information on the status of each beam via the RS 485 serial line	Solution providing simple on/off information related to the status of the controlled area	Data available via the IO-Link protocol data mapping: NCBO, NBO, CBO, LBO, FBO, curtain status, object detected, individual beam status



MEASUREMENT AND AUTOMATION LIGHT CURTAINS

TYPICAL APPLICATIONS

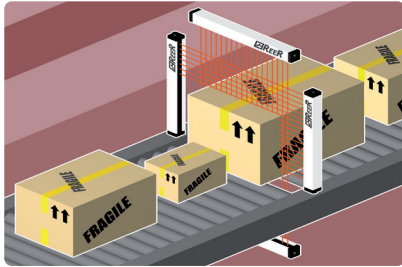

Measurement of the height of objects in transit on conveyor systems. Two-dimensional detection of objects in transit with use of 2 sets of light curtains

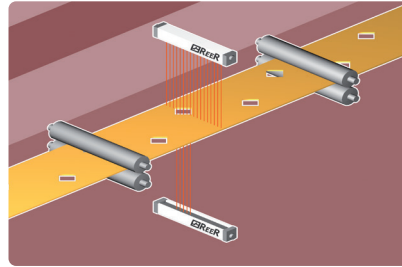

Quality control: verification of presence / absence / position of holes

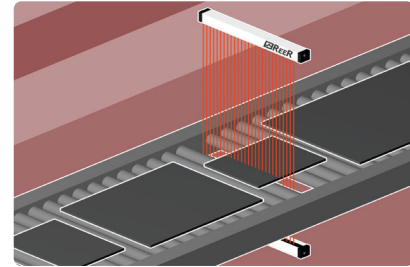

Measurement of the width and position of panels or sheets of material in transit on roller units or conveyor belts

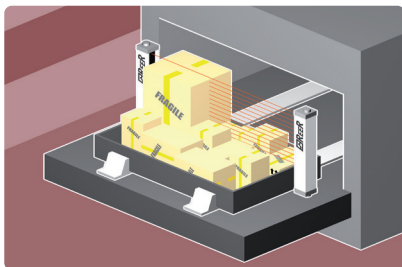

Automatic warehouses: detection of maximum height of the objects present in the tray for efficient management of the machine's capacity

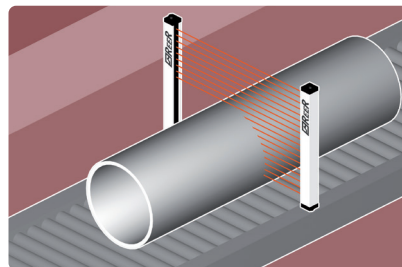

Measurement and identification of cylinders of various sizes

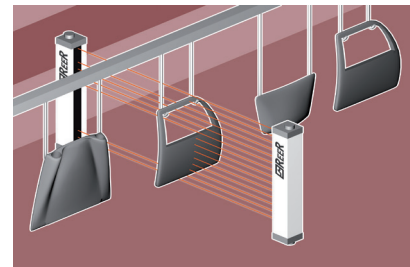

Detection of position and profile of workpieces in automated painting systems

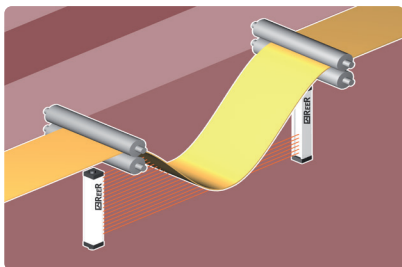

Loop control

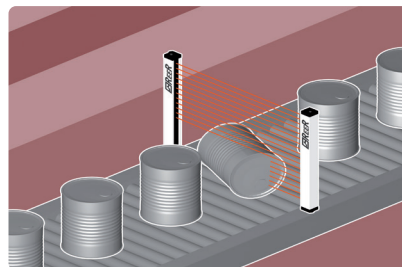

Quality control: verification of correct positioning of objects

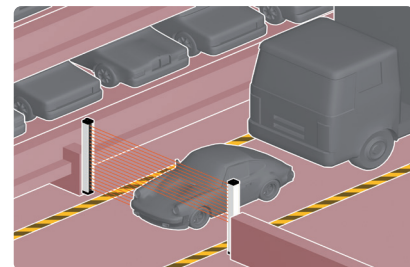

Detection of overall dimensional limits of vehicles in automated parking garages

MUTING AND AUTOMATION PHOTOCELLS



BACKLIT TOP COVER WITH STATUS LED

M⁵ MULTI-BEAM PHOTOCCELL

Through-beam barrier type photocell with 5 beams.

M⁵ [1250910] A coding photocell (range 0 ... 3,5 m)

M⁵ [1250911] B coding photocell (range 0 ... 3,5 m)

M⁵H [1250916] A coding high range photocell (range 0 ... 5 m)

M⁵H [1250917] B coding high range photocell (range 0 ... 5 m)

M^{TRX} RETRO-REFLECTIVE PHOTOCCELL

Single-beam retro-reflective photocell, consisting of active TX/RX element and retro-reflector (to be ordered separately).

M^{TRX} [1250912] A coding retro-reflective photocell

M^{TRX} [1250913] B coding retro-reflective photocell

CD8 [1210032] Retro-reflector (range 0 ... 5)

C3F8 [1210221] Retro-reflector (range 0 ... 3,5)

C3F10 [1210035] Retro-reflector (range 0 ... 2,5)

Part numbers on request

All Micron models can be manufactured with WTF or WTHF watertight enclosure (factory programmed only) for use in harsh working environments with exposure to water and steam.



ECOLAB®



PART NUMBERS

Beam spacing 5 mm

Micron A (AV)	MI 150AV	MI 300AV	MI 450AV	MI 600AV	MI 750AV	MI 900AV	MI 1050AV	MI 1200AV	MI 1350AV	MI 1500AV
Part number	1250580	1250581	1250582	1250583	1250584	1250585	1250586	1250587	1250588	1250589
Micron A (AC)	MI 150AC	MI 300AC	MI 450AC	MI 600AC	MI 750AC	MI 900AC	MI 1050AC	MI 1200AC	MI 1350AC	MI 1500AC
Part number	1250520	1250521	1250522	1250523	1250524	1250525	1250526	1250527	1250528	1250529
Micron B	MI 150B	MI 300B	MI 450B	MI 600B	MI 750B	MI 900B	MI 1050B	MI 1200B	MI 1350B	MI 1500B
Part number	1250540	1250541	1250542	1250543	1250544	1250545	1250546	1250547	1250548	1250549
Micron C	MI 150C	MI 300C	MI 450C	MI 600C	MI 750C	MI 900C	MI 1050C	MI 1200C	MI 1350C	MI 1500C
Part number	1250560	1250561	1250562	1250563	1250564	1250565	1250566	1250567	1250568	1250569
Measuring height (mm)	145	295	395	595	745	895	1045	1195	1345	1495
Number of beams	30	60	90	120	150	180	210	240	270	300
Overall height (mm)	223	373	523	673	823	973	1123	1273	1423	1573

CABLES NEEDED

Micron A and Micron B

Emitter: M12 5-pole (CDx)

Receiver: M12 8-pole (C8Dx)

Programming: M5 4-pole (CSU M5)

Micron C

Emitter: M12 5-pole (CDx)

Receiver: M12 5-pole (CDx)

Micron IO-Link

Emitter: M12 5-pole (CDx or CFM5Px)

Receiver: M12 5-pole (CDx ou CFM5Px)

Y Splitter cable M 12 5-pole. For 24 V transmitter and Sync receiver connection. (CSYIOLH High range configuration) or (CSYIOLL Low range configuration)

Beam spacing 10 mm

Micron A (AV)	MI 151AV	MI 301AV	MI 451AV	MI 601AV	MI 751AV	MI 901AV	MI 1051AV	MI 1201AV	MI 1351AV	MI 1501AV	MI 1651AV	MI 1801AV	MI 1951AV	MI 2101AV	MI 2251AV	MI 2401AV	MI 2551AV	MI 2701AV	MI 2851AV	MI 3001AV
Part number	1250020	1250021	1250022	1250023	1250024	1250025	1250026	1250027	1250028	1250029	1250030	1250031	1250032	1250033	1250034	1250035	1250036	1250037	1250038	1250039
Micron A (AC)	MI 151AC	MI 301AC	MI 451AC	MI 601AC	MI 751AC	MI 901AC	MI 1051AC	MI 1201AC	MI 1351AC	MI 1501AC	MI 1651AC	MI 1801AC	MI 1951AC	MI 2101AC	MI 2251AC	MI 2401AC	MI 2551AC	MI 2701AC	MI 2851AC	MI 3001AC
Part number	1250120	1250121	1250122	1250123	1250124	1250125	1250126	1250127	1250128	1250129	1250130	1250131	1250132	1250133	1250134	1250135	1250136	1250137	1250138	1250139
Micron B	MI 151B	MI 301B	MI 451B	MI 601B	MI 751B	MI 901B	MI 1051B	MI 1201B	MI 1351B	MI 1501B	MI 1651B	MI 1801B	MI 1951B	MI 2101B	MI 2251B	MI 2401B	MI 2551B	MI 2701B	MI 2851B	MI 3001B
Part number	1250220	1250221	1250222	1250223	1250224	1250225	1250226	1250227	1250228	1250229	1250230	1250231	1250232	1250233	1250234	1250235	1250236	1250237	1250238	1250239
Micron C	MI 151C	MI 301C	MI 451C	MI 601C	MI 751C	MI 901C	MI 1051C	MI 1201C	MI 1351C	MI 1501C	MI 1651C	MI 1801C	MI 1951C	MI 2101C	MI 2251C	MI 2401C	MI 2551C	MI 2701C	MI 2851C	MI 3001C
Part number	1250320	1250321	1250322	1250323	1250324	1250325	1250326	1250327	1250328	1250329	1250330	1250331	1250332	1250333	1250334	1250335	1250336	1250337	1250338	1250339
Micron IO-Link	MI 151IOL	MI 301IOL	MI 451IOL	MI 601IOL	MI 751IOL	MI 901IOL	MI 1051IOL	MI 1201IOL	MI 1351IOL	MI 1501IOL	MI 1651IOL	MI 1801IOL	MI 1951IOL	MI 2101IOL	MI 2251IOL	MI 2401IOL	MI 2551IOL	MI 2701IOL	MI 2851IOL	MI 3001IOL
Part number	1250700	1250701	1250702	1250703	1250704	1250705	1250706	1250707	1250708	1250709	1250710	1250711	1250712	1250713	1250714	1250715	1250716	1250717	1250718	1250719
Measuring height (mm)	140	290	440	590	740	890	1040	1190	1340	1490	1640	1790	1940	2090	2240	2390	2540	2690	2840	2990
Number of beams	15	30	45	60	75	90	105	120	135	150	165	180	195	210	225	240	255	270	285	300
Overall height (mm)	213	363	513	663	813	963	1113	1263	1413	1563	1713	1863	2013	2163	2313	2463	2613	2763	2913	3063



Beam spacing 25 mm

Micron IO-Link 25 mm

Micron A (AV)	MI 152AV	MI 302AV	MI 452AV	MI 602AV	MI 752AV	MI 902AV	MI 1052AV	MI 1202AV	MI 1352AV	MI 1502AV	MI 1652AV	MI 1802AV	MI 1952AV	MI 2102AV	MI 2252AV	MI 2402AV	MI 2552AV	MI 2702AV	MI 2852AV	MI 3002AV
Part number	1250040	1250041	1250042	1250043	1250044	1250045	1250046	1250047	1250048	1250049	1250050	1250051	1250052	1250053	1250054	1250055	1250056	1250057	1250058	1250059
Micron A (AC)	MI 152AC	MI 302AC	MI 452AC	MI 602AC	MI 752AC	MI 902AC	MI 1052AC	MI 1202AC	MI 1352AC	MI 1502AC	MI 1652AC	MI 1802AC	MI 1952AC	MI 2102AC	MI 2252AC	MI 2402AC	MI 2552AC	MI 2702AC	MI 2852AC	MI 3002AC
Part number	1250140	1250141	1250142	1250143	1250144	1250145	1250146	1250147	1250148	1250149	1250150	1250151	1250152	1250153	1250154	1250155	1250156	1250157	1250158	1250159
Micron B	MI 152B	MI 302B	MI 452B	MI 602B	MI 752B	MI 902B	MI 1052B	MI 1202B	MI 1352B	MI 1502B	MI 1652B	MI 1802B	MI 1952B	MI 2102B	MI 2252B	MI 2402B	MI 2552B	MI 2702B	MI 2852B	MI 3002B
Part number	1250240	1250241	1250242	1250243	1250244	1250245	1250246	1250247	1250248	1250249	1250250	1250251	1250252	1250253	1250254	1250255	1250256	1250257	1250258	1250259
Micron C	MI 152C	MI 302C	MI 452C	MI 602C	MI 752C	MI 902C	MI 1052C	MI 1202C	MI 1352C	MI 1502C	MI 1652C	MI 1802C	MI 1952C	MI 2102C	MI 2252C	MI 2402C	MI 2552C	MI 2702C	MI 2852C	MI 3002C
Part number	1250340	1250341	1250342	1250343	1250344	1250345	1250346	1250347	1250348	1250349	1250350	1250351	1250352	1250353	1250354	1250355	1250356	1250357	1250358	1250359
Micron IO-Link	MI 152IOL	MI 302IOL	MI 452IOL	MI 602IOL	MI 752IOL	MI 902IOL	MI 1052IOL	MI 1202IOL	MI 1352IOL	MI 1502IOL	MI 1652IOL	MI 1802IOL	MI 1952IOL	MI 2102IOL	MI 2252IOL	MI 2402IOL	MI 2552IOL	MI 2702IOL	MI 2852IOL	MI 3002IOL
Part number	1250740	1250741	1250742	1250743	1250744	1250745	1250746	1250747	1250748	1250749	1250750	1250751	1250752	1250753	1250754	1250755	1250756	1250757	1250758	1250759
Measuring height (mm)	125	275	425	575	725	875	1025	1175	1325	1475	1625	1775	1925	2075	2225	2375	2525	2625	2825	2975
Number of beams	6	12	18	24	30	36	42	48	54	60	66	72	78	84	90	96	102	108	114	120
Overall height (mm)	213	363	513	663	813	963	1113	1263	1413	1563	1713	1863	2013	2163	2313	2463	2613	2763	2913	3063

Micron

PART NUMBERS

Beam spacing 30 mm

Micron A (AV)	MI 153AV	MI 303AV	MI 453AV	MI 603AV	MI 753AV	MI 903AV	MI 1053AV	MI 1203AV	MI 1353AV	MI 1503AV	MI 1653AV	MI 1803AV	MI 1953AV	MI 2103AV	MI 2253AV	MI 2403AV	MI 2553AV	MI 2703AV	MI 2853AV	MI 3003AV
Part number	1250060	1250061	1250062	1250063	1250064	1250065	1250066	1250067	1250068	1250069	1250070	1250071	1250072	1250073	1250074	1250075	1250076	1250077	1250078	1250079
Micron A (AC)	MI 153AC	MI 303AC	MI 453AC	MI 603AC	MI 753AC	MI 903AC	MI 1053AC	MI 1203AC	MI 1353AC	MI 1503AC	MI 1653AC	MI 1803AC	MI 1953AC	MI 2103AC	MI 2253AC	MI 2403AC	MI 2553AC	MI 2703AC	MI 2853AC	MI 3003AC
Part number	1250160	1250161	1250162	1250163	1250164	1250165	1250166	1250167	1250168	1250169	1250170	1250171	1250172	1250173	1250174	1250175	1250176	1250177	1250178	1250179
Micron B	MI 153B	MI 303B	MI 453B	MI 603B	MI 753B	MI 903B	MI 1053B	MI 1203B	MI 1353B	MI 1503B	MI 1653B	MI 1803B	MI 1953B	MI 2103B	MI 2253B	MI 2403B	MI 2553B	MI 2703B	MI 2853B	MI 3003B
Part number	1250260	1250261	1250262	1250263	1250264	1250265	1250266	1250267	1250268	1250269	1250270	1250271	1250272	1250273	1250274	1250275	1250276	1250277	1250278	1250279
Micron C	MI 153C	MI 303C	MI 453C	MI 603C	MI 753C	MI 903C	MI 1053C	MI 1203C	MI 1353C	MI 1503C	MI 1653C	MI 1803C	MI 1953C	MI 2103C	MI 2253C	MI 2403C	MI 2553C	MI 2703C	MI 2853C	MI 3003C
Part number	1250360	1250361	1250362	1250363	1250364	1250365	1250366	1250367	1250368	1250369	1250370	1250371	1250372	1250373	1250374	1250375	1250376	1250377	1250378	1250379
Micron IO-Link	MI 153IOL	MI 303IOL	MI 453IOL	MI 603IOL	MI 753IOL	MI 903IOL	MI 1053IOL	MI 1203IOL	MI 1353IOL	MI 1503IOL	MI 1653IOL	MI 1803IOL	MI 1953IOL	MI 2103IOL	MI 2253IOL	MI 2403IOL	MI 2553IOL	MI 2703IOL	MI 2853IOL	MI 3003IOL
Part number	1250720	1250721	1250722	1250723	1250724	1250725	1250726	1250727	1250728	1250729	1250730	1250731	1250732	1250733	1250734	1250735	1250736	1250737	1250738	1250739
Measuring height (mm)	120	270	420	570	720	870	1020	1170	1320	1470	1620	1770	1920	2070	2220	2370	2520	2670	2820	2970
Number of beams	5	10	15	20	25	30	35	40	45	50	55	60	65	70	75	80	85	90	95	100
Overall height (mm)	213	363	513	663	813	963	1113	1263	1413	1563	1713	1863	2013	2163	2313	2463	2613	2763	2913	3063

Beam spacing 50 mm

Micron A (AV)	MI 155AV	MI 305AV	MI 455AV	MI 605AV	MI 755AV	MI 905AV	MI 1055AV	MI 1205AV	MI 1355AV	MI 1505AV	MI 1655AV	MI 1805AV	MI 1955AV	MI 2105AV	MI 2255AV	MI 2405AV	MI 2555AV	MI 2705AV	MI 2855AV	MI 3005AV
Part number	1250080	1250081	1250082	1250083	1250084	1250085	1250086	1250087	1250088	1250089	1250090	1250091	1250092	1250093	1250094	1250095	1250096	1250097	1250098	1250099
Micron A (AC)	MI 155AC	MI 305AC	MI 455AC	MI 605AC	MI 755AC	MI 905AC	MI 1055AC	MI 1205AC	MI 1355AC	MI 1505AC	MI 1655AC	MI 1805AC	MI 1955AC	MI 2105AC	MI 2255AC	MI 2405AC	MI 2555AC	MI 2705AC	MI 2855AC	MI 3005AC
Part number	1250180	1250181	1250182	1250183	1250184	1250185	1250186	1250187	1250188	1250189	1250190	1250191	1250192	1250193	1250194	1250195	1250196	1250197	1250198	1250199
Micron B	MI 155B	MI 305B	MI 455B	MI 605B	MI 755B	MI 905B	MI 1055B	MI 1205B	MI 1355B	MI 1505B	MI 1655B	MI 1805B	MI 1955B	MI 2105B	MI 2255B	MI 2405B	MI 2555B	MI 2705B	MI 2855B	MI 3005B
Part number	1250280	1250281	1250282	1250283	1250284	1250285	1250286	1250287	1250288	1250289	1250290	1250291	1250292	1250293	1250294	1250295	1250296	1250297	1250298	1250299
Micron C	MI 155C	MI 305C	MI 455C	MI 605C	MI 755C	MI 905C	MI 1055C	MI 1205C	MI 1355C	MI 1505C	MI 1655C	MI 1805C	MI 1955C	MI 2105C	MI 2255C	MI 2405C	MI 2555C	MI 2705C	MI 2855C	MI 3005C
Part number	1250380	1250381	1250382	1250383	1250384	1250385	1250386	1250387	1250388	1250389	1250390	1250391	1250392	1250393	1250394	1250395	1250396	1250397	1250398	1250399
Measuring height (mm)	100	250	400	550	700	850	1000	1150	1300	1450	1600	1750	1900	2050	2200	2350	2500	2650	2800	2950
Number of beams	3	6	9	12	15	18	21	24	27	30	33	36	39	42	45	48	51	54	57	60
Overall height (mm)	213	363	513	663	813	963	1113	1263	1413	1563	1713	1863	2013	2163	2313	2463	2613	2763	2913	3063

Beam spacing 75 mm

Micron A (AV)	MI 157AV	MI 307AV	MI 457AV	MI 607AV	MI 757AV	MI 907AV	MI 1057AV	MI 1207AV	MI 1357AV	MI 1507AV	MI 1657AV	MI 1807AV	MI 1957AV	MI 2107AV	MI 2257AV	MI 2407AV	MI 2557AV	MI 2707AV	MI 2857AV	MI 3007AV
Part number	1250100	1250101	1250102	1250103	1250104	1250105	1250106	1250107	1250108	1250109	1250110	1250111	1250112	1250113	1250114	1250115	1250116	1250117	1250118	1250119
Micron A (AC)	MI 157AC	MI 307AC	MI 457AC	MI 607AC	MI 757AC	MI 907AC	MI 1057AC	MI 1207AC	MI 1357AC	MI 1507AC	MI 1657AC	MI 1807AC	MI 1957AC	MI 2107AC	MI 2257AC	MI 2407AC	MI 2557AC	MI 2707AC	MI 2857AC	MI 3007AC
Part number	1250200	1250201	1250202	1250203	1250204	1250205	1250206	1250207	1250208	1250209	1250210	1250211	1250212	1250213	1250214	1250215	1250216	1250217	1250218	1250219
Micron B	MI 157B	MI 307B	MI 457B	MI 607B	MI 757B	MI 907B	MI 1057B	MI 1207B	MI 1357B	MI 1507B	MI 1657B	MI 1807B	MI 1957B	MI 2107B	MI 2257B	MI 2407B	MI 2557B	MI 2707B	MI 2857B	MI 3007B
Part number	1250300	1250301	1250302	1250303	1250304	1250305	1250306	1250307	1250308	1250309	1250310	1250311	1250312	1250313	1250314	1250315	1250316	1250317	1250318	1250319
Micron C	MI 157C	MI 307C	MI 457C	MI 607C	MI 757C	MI 907C	MI 1057C	MI 1207C	MI 1357C	MI 1507C	MI 1657C	MI 1807C	MI 1957C	MI 2107C	MI 2257C	MI 2407C	MI 2557C	MI 2707C	MI 2857C	MI 3007C
Part number	1250400	1250401	1250402	1250403	1250404	1250405	1250406	1250407	1250408	1250409	1250410	1250411	1250412	1250413	1250414	1250415	1250416	1250417	1250418	1250419
Measuring height (mm)	75	225	375	525	675	825	975	1125	1275	1425	1575	1725	1875	2025	2175	2325	2475	2625	2775	2925
Number of beams	2	4	6	8	10	12	14	16	18	20	22	24	26	28	30	32	34	36	38	40
Overall height (mm)	213	363	513	663	813	963	1113	1263	1413	1563	1713	1863	2013	2163	2313	2463	2613	2763	2913	3063

SPECIAL MODELS

Automatic warehouse applications models	Beams spacing 25, 50, 75 mm
20 mm models	Beams spacing 20 mm
AH models	Beams spacing 10 and 30 mm with range up to 18 m

Please contact ReeR for availability and models

PERIMETER PROTECTIONS

FLOOR-MOUNTED COLUMNS

EOS and MICRON light curtains

Model	Part number	For light curtains with protected height
FMC EB2	1207814	310, 460, 610 mm and 2 beams
FMC EB4	1207815	760, 910, 1060 mm, 3 and 4 beams
FMC EB 1700	1207816	Up to 1360 mm
FMC EB 2000	1207817	Up to 1660 mm
FMC EB 2200	1207819	Up to 1800 mm
FMC EB 2400	1207818	Up to 2100 mm
FMC EB 2 R	1207824	310, 460, 610 mm and 2 beams
FMC EB 4 R	1207825	760, 910, 1060 mm, 3 and 4 beams
FMC EB 1700 R	1207826	Up to 1360 mm
FMC EB 2000 R	1207827	Up to 1660 mm



ADMIRAL light curtains

Model	Part number	For light curtains with protected height
FMC B2	1200610	2 beams
FMC B3	1200611	3 beams
FMC B4	1200612	4 beams
FMC B 1700	1200618	Up to 1360 mm
FMC B 2000	1200616	Up to 1660 mm
FMC B 2 R	1200613	2 beams
FMC B 3 R	1200614	3 beams
FMC B 4 R	1200615	4 beams
FMC B 1700 R	1200617	Up to 1360 mm
FMC B 2000 R	1200619	Up to 1660 mm



All models

Model	Part number	Description
FMC B12	1200502	Support column height 1200 mm, dimensions 60 x 30 mm
FMC B18	1200505	Support column height 1800 mm, dimensions 80 x 80 mm



SAFEGATE light curtains

Model	Part number	For light curtains with protected height
FMC SG B2	1200700	2 beams
FMC SG B3	1200701	3 beams
FMC SG B4	1200702	4 beams
FMC SG 1700	1200703	Up to 1360 mm
FMC SG 2000	1200704	Up to 1660 mm
FMC SG B2 R	1200705	2 beams
FMC SG B3 R	1200706	3 beams
FMC SG B4 R	1200707	4 beams
FMC SG 1700 R	1200708	Up to 1360 mm
FMC SG 2000 R	1200709	Up to 1660 mm



COLUMNS WITH DEFLECTING MIRRORS

Model	Part number	Description
FMC S2	1200620	Single mirror for 2 beams light curtains
FMC S3	1200621	Single mirror for 3 beams light curtains
FMC S4	1200622	Single mirror for 4 beams light curtains
FMC S 1700	1200625	Single mirror for controlled height up to 1360 mm light curtains
FMC S 2000	1200623	Single mirror for controlled height up to 1660 mm light curtains
FMC S2200	1200628	Single mirror for controlled height up to 1800 mm light curtains
FMC SB2	1200645	2 adjustable deflecting mirrors for 2 beams light curtains
FMC SB3	1200646	3 adjustable deflecting mirrors for 3 beams light curtains
FMC SB4	1200647	4 adjustable deflecting mirrors for 4 beams light curtains

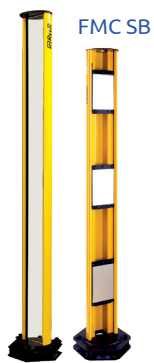

DEFLECTING MIRRORS

Model	Part number	Mirror height (mm)	For light curtains with protected height (mm)
SP 100 S	1201805	250	160
SP 200 S	1201800	370	250
SP 300 S	1201806	400	310
SP 400 S	1201801	540	460
SP 600 S	1201811	715	610 or 2 beams
SP 700 S	1201802	885	760
SP 900 S	1201812	1065	910 or 3 beams
SP 1100 S	1201803	1230	1060 or 4 beams
SP 1200 S	1201810	1400	1210
SP 1300 S	1201807	1450	1360
SP 1500 S	1201808	1600	1510
SP 1600 S	1201813	1750	1600
SP 1800 S	1201809	1900	1810



BASES FOR COLUMNS

All column models

Model	Part number	Description
FMC CB	1200500	Standard base
FMC CBL	1200501	Reduced height base



Note: Columns part numbers do not include the base which must be ordered separately

ACCESSORIES

CABLES AND BRACKETS

BRACKETS AND VIBRATION DAMPERS

EOS, MICRON			SAFEGATE	ADMIRAL	DAMPERS	
						
SFB 4E [1310976] Set of 4 swivel brackets SFB 6E [1310977] Set of 6 swivel brackets	SFB E180 [1310980] Set of 4 180° swivel brackets	FE 4 [1310997] Set of 4 flat brackets	SFB FAST 4E [1310969] Set of 4 fast-coupling brackets	SFB 4SG [1390950] Set of 4 adjustable brackets SFB 6SG [1390951] Set of 6 adjustable brackets	SFB [1330974] Set of 4 swivel brackets	SAV-4E [1310972] SAV-8E [1310973] SAV-12E [1310974] Sets of 4, 8, 12 vibration dampers for EOS end MICRON SAV-3 [1200088] SAV-4 [1200089] Sets of 2, 3 vibration dampers for ADMIRAL

CABLES

Straight connector cables		90° angle connector cables		Extension cables	
M12 5-pole female straight connector	M12 8-pole female straight connector	M12 5-pole female 90° angle connector	Cable with 2 female straight connectors M12 5-pole	Cable with 2 male/female straight connectors M12 5-pole	
CD3 [1330969] 3 m CD5 [1330950] 5 m CD10 [1330956] 10 m CD15 [1330952] 15 m CD20 [1330957] 20 m CD25 [1330949] 25 m CD40 [1330907] 40 m CD50 [1330965] 50 m	C8D5 [1330980] 5 m C8D10 [1330981] 10 m C8D15 [1330982] 15 m C8D20 [1330908] 20 m C8D25 [1330967] 25 m C8D40 [1330966] 40 m C8D50 [1330909] 50 m M12 8-pole female straight connector for R-Safe sensors CF8P3 [1295103] 3 m CF8P5 [1295104] 5 m CF8P10 [1295105] 10 m	CD95 [1330951] 5 m CD910 [1330958] 10 m CD915 [1330953] 15 m	CDS03 [1330990] 0,3 m CDS01 [1330968] 1 m CJBE3 [1360960] 3 m CJBE5 [1360961] 5 m CJBE10 [1360962] 10 m CJBE25 [1360963] 25 m	CFM5P3 [1390908] 3 m CFM5P5 [1390909] 5 m CFM5P10 [1390911] 10 m Cable with 2 male/female straight connectors M12 8-pole CFM8P3 [1295100] 3 m CFM8P5 [1295101] 5 m CFM8P10 [1295102] 10 m	
M12 5-pole shielded female straight connector	M12 8-pole shielded female straight connector	M12 8-pole female 90° angle connector	Cable with 2 female straight connectors M12 8-pole	Cable with 2 female straight connectors M12 12-pole	
CD5 SB [1330850] 5 m CD10 SB [1330856] 10 m CD15 SB [1330852] 15 m	C8D5 SB [1330880] 5 m C8D10 SB [1330881] 10 m C8D15 SB [1330882] 15 m	C8D95 [1330983] 5 m C8D910 [1330984] 10 m C8D915 [1330985] 15 m	CFF8P3 [1390918] 3 m CFF8P5 [1390919] 5 m CFF8P10 [1390920] 10 m	CFF12P3 [1390912] 3 m CFF12P5 [1390913] 5 m CFF12P10 [1390914] 10 m	
M12 5-pole male straight connector	M12 12-pole female straight connector	 <p>Other cables lengths and versions available on request. Visit reersafety.com</p>			
CJS1 [1390915] 1 m CJS3 [1390916] 3 m	CS12D3 [1390900] 3 m CS12D5 [1390901] 5 m CS12D10 [1390902] 10 m CS12D15 [1390906] 15 m CS12D20 [1390907] 20 m				

LASER ALIGNMENT DEVICES

LAD 4 [1310975] For EOS and MICRON light curtains

LAD 2 [1220301] For ADMIRAL light curtains

LAD 5 [1390940] For SAFEGATE light curtains



A REFERENCE FOR SAFETY AT WORK

We actively participate in several National, European and International (IEC) Standard Committees on Machine Safety, allowing us to be always at the forefront about products standards compliance.

- ISO/TC 199 - CEN/TC 114
- IEC/TC44 - CLC/TC 44X
- CEI/TC 44
- UNI Safety Committee

ReeR participates in the development of the following international standards:

- IEC 61496-1: Safety of Machinery - Electro-Sensitive Protective Equipment Part 1: General requirements and tests
- IEC 61496-2: Safety of Machinery - Electro-Sensitive Protective Equipment Part 2: Particular requirements for equipment using Active Opto-electronic Protective Devices (AOPDs)
- IEC 61496-3: Safety of Machinery - Electro-Sensitive Protective Equipment - Part 3: Particular requirements for Active Opto-electronic Protective Devices responsive to Diffuse Reflection (AOPDDR)
- IEC 61496-4-2: Safety of machinery - Electro-sensitive protective equipment - Part 4-2: Particular requirements for equipment using vision based protective devices (VBPD) - Additional requirements when using stereo vision techniques (VBPDST)
- IEC 61496-4-3: Safety of machinery - Electro-sensitive protective equipment - Part 4-3: Particular requirements for equipment using vision based protective devices (VBPD) - Additional requirements when using reference pattern techniques (VBPDP)
- IEC 62046: Safety of Machinery - Application of protective equipment to detect the presence of persons
- ISO 13849-1: Safety of machinery - Safety related parts of control system - Part 1: General principles for design
- ISO 13850: Safety of machinery - Emergency Stop - Principles for design
- ISO-IEC 17305 (Draft): Safety of machinery - Safety functions of control systems



COMPANY CERTIFICATIONS



ReeR Customer Service is committed to support all customers that need technical guidance regarding functionality, handling and installation of our products.

Customer Service Hotline

+39 011 24 82 215 or contact aftersales@reer.it

Monday to Friday 8.30 - 12.30 and 13.30-18.00 (CET)



Your future's safe!



More than 60 years of quality and innovation

Founded in Turin, Italy in 1959, ReeR prides itself in its strong commitment to innovation and technology.

ReeR's steady growth since its inception is a result of being a leader in the global safety automation industry.

Today, the Safety Division is a world leader in the development and manufacturing of safety optoelectronic sensors and controllers.

ReeR is ISO 9001, ISO 14001 and ISO 45001 certified.



ReeR SpA

Via Carcano, 32
10153 Torino, Italy

T +39 011 248 2215

F +39 011 859 867

www.reersafety.com | info@reer.it



Issue 1 - Rev. 1.5
July 2023
8946053
Panorama - English

Printed in Italy

ReeR SpA does not guarantee that product information in this catalogue are the most current available. ReeR SpA reserves the right to make changes to the products described without notice and assumes no liability as a result of their use or application. Our goal is to keep the information on this catalogue timely and accurate, however ReeR SpA accepts no responsibility or liability whatsoever with regard to the information on this catalogue. Reproduction is not authorised, except with the expressed permission of ReeR SpA.