

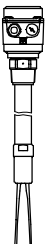

Table of contents

	Page
Specifications/ Applications	2

VN 4020 Short extension length	4
	

VN 4030 Pipe extension	6
	

VN 4040 Pipe extension (screwed)	8
	

Options	10
Dimensions	12
Spare parts	13
Electrical installation	14

Wolf Process Automation Limited | Tel: +353 45 831575 | Email: info@wpa.ie | Web: www.wpa.ie

Subject to change.

Valid: From 01.04.2018 until 31.03.2019, unless otherwise agreed.

All dimensions in mm (inches).

By publishing this selection list all other lists become invalid.

All prices in Euro (€) or USD (\$), excluding VAT.

We assume no liability for typing errors.

All EURO prices are EXW Betzigau, all USD prices are EXW Memphis, excluding packaging costs.

Different variations to those specified are possible. Please contact our technical consultants.

Specifications

- Level limit detection in bulk goods/ solids
- Compact unit
- Die-casted housing aluminium
- Wide range of applications, no maintenance
- Full-, demand-, empty detector
- Sensitivity > 30 g/l (1.9lb/ft³)
- ATEX, IEC-Ex, FM, CSA, TR-CU approvals (DustEx)
- 1935/2004/EC Food grade materials
- 2011/65/EU RoHS conform

Approvals	CE	
	ATEX/ IEC-Ex	Zone 20/21 (Dust Ignition Proof)
	FM/ CSA	Ordinary Locations Cl. II, III Div. 1 (Dust Ignition Proof)
	TR-CU	Ordinary Locations Zone 20/21 (Dust Ignition Proof)

Electro-nics	Relay DPDT	19 .. 230 V AC 19 .. 40 V DC ±10%
	PNP	18 .. 50 V DC ±10%

VN 4020	Length of extension	170 mm (6.68")
	Ambient temperature	-40 .. +60°C (-40 .. +140°F)
	Process temperature	-40 .. +150°C (-40 .. +302°F)
	Process pressure	-1 .. +16 bar (-14.5 .. +232 psi)
	Process connection material/ Extension	1.4581 (316) or 1.4541 (321) (food grade)

VN 4030	Length of extension	300 .. 4,000 mm (11.8 .. 157")
	Ambient temperature	-40 .. +60°C (-40 .. +140°F)
	Process temperature	-40 .. +150°C (-40 .. +302°F)
	Process pressure	-1 .. +16 bar (-14.5 .. +232 psi)
	Process connection material/ Extension	1.4301 (304)/ 1.4541 (321) or 1.4571 (316TI)/ 1.4404 (316L) (food grade)

VN 4040	Length of extension	max. 1,500 mm (59") or 4,000 mm (157")
	Ambient temperature	-40 .. +60°C (-40 .. +140°F)
	Process temperature	-40 .. +150°C (-40 .. +302°F)
	Process pressure	-1 .. +16 bar (-14.5 .. +232 psi)
	Process connection material/ Extension	1.4305 (303)/ 1.4541 (321) or 1.4571 (316TI)/ 1.4404 (316L) (food grade)

VN 4020



VN 4040



VN 4030



Applications

Detection of solids

VN 4020

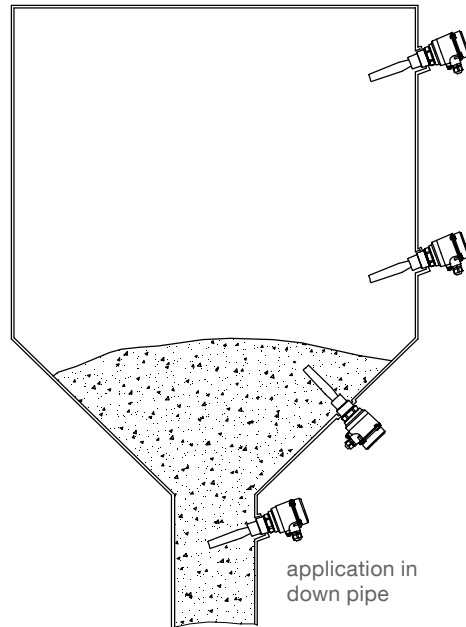

VN 4030
VN 4040

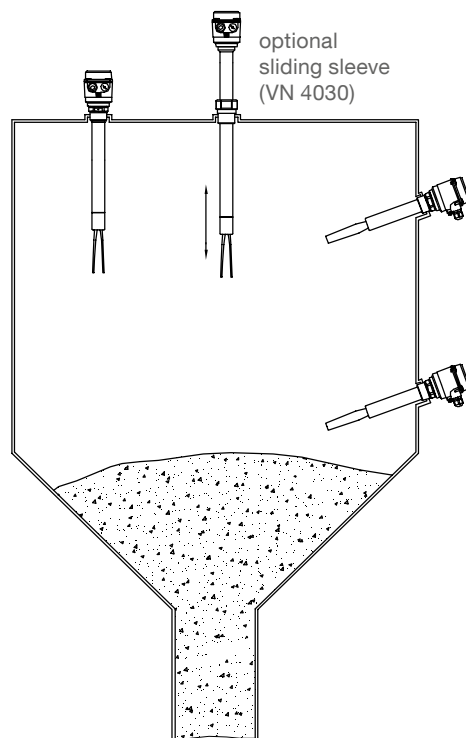

VN 4020 Short extension length



Food grade materials

Cable entries (by default)

Depending on model selected the following cable entries are supported (options see pos.23 on page 10):

Version:	Cable entries:
CE/ ATEX/ IEC-Ex/ TR-CU (pos.2 0,W,F,E)	M20 x 1.5 (1x cable gland + 1x blind plug)
FM and CSA (pos.2 M,N)	NPT ½" tapered ANSI B1.20.1 (1x open conduit + 1x blind plug)

Dimensions see page 12

pos.3
 Temperature extended shaft

Application up to 150°C
 (302°F)

- 1 without
- 2 with

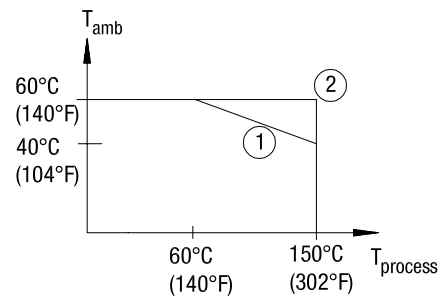
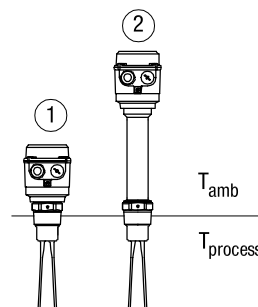

VN 4020 Short extension length

Basic type

VN 4020 ●

pos.2 **Certificate**

- 0 CE ⁽¹⁾ ●
- W ATEX II 1/2D Ex ta/tb IIIC T! Da/Db ●
- A IEC-Ex ta/tb IIIC T! Da/Db ●
- M FM/ CSA General Purpose ●
- N FM/ CSA DIP Cl. II, III Div.1 Group E, F, G and CSA DIP A20/21 ●
- E TR-CU Ex ta/tb IIIC T! Da/Db X ●

pos.3 **Temperature extended shaft**

- 1 without (up to $T_{process} = 150^{\circ}C$ (302°F) at $T_{amb} < 40^{\circ}C$ (104°F)) ●
- 2 with (up to $T_{process} = 150^{\circ}C$ (302°F) at $T_{amb} > 40^{\circ}C$ (104°F)) ●

pos.4 **Electronic module**

- L Relay DPDT 19 .. 230 V AC 19 .. 40 V DC ●
- D PNP 18 .. 50 V DC ●

pos.5 **Process connection**

- A Thread R 1½", conical EN 10226 ●
- B Thread NPT 1½", conical ANSI B1.20.1 ●
- D Thread NPT 1¼", conical ANSI B1.20.1 ●
- P Triclamp 2" (DN50) ISO 2852 ●
- L Flange DN100 PN6, EN 1092-1 (max. 6 bar (87 psi)) ●
- M Flange DN100 PN16, EN 1092-1 ●
- S Flange 2" 150lbs ANSI B16.5 ●
- T Flange 3" 150lbs ANSI B16.5 ●
- U Flange 4" 150lbs ANSI B16.5 ●

pos.8 **Material of process connection/ extension "L"**

- 1 Stainless steel 1.4541 (321) ●
- 2 Stainless steel 1.4581 (316)/ 1.4404 (316L) ●

Further options: see page 10

VN 4020	A					3	1	
position 1	2	3	4	5	6	7	8	

← **Order code**

All positions are available in special design (use code "Z").

⁽¹⁾ TR-CU (general purpose) included

VN 4030 Pipe extension



Food grade materials

Cable entries (by default)

Depending on model selected the following cable entries are supported (options see pos.23 on page 10):

Version:	Cable entries:
CE/ ATEX/ IEC-Ex/ TR-CU (pos.2 0,W,F,E)	M20 x 1.5 (1x cable gland + 1x blind plug)
FM and CSA (pos.2 M,N)	NPT ½" tapered ANSI B1.20.1 (1x open conduit + 1x blind plug)

Dimensions

see page 12

pos.3
 Temperature extended shaft

Application up to 150°C (302°F)

- 1 without
- 2 without and with extended socket
- 3 with

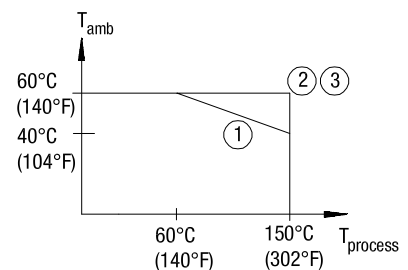
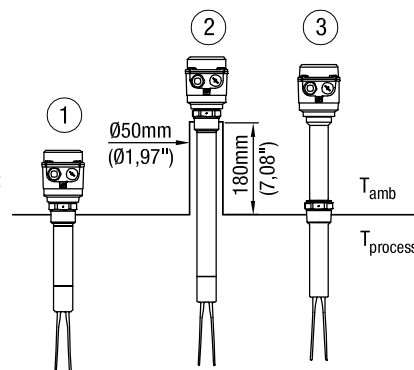

VN 4040 Pipe extension (screwed)



Food grade materials

Cable entries (by default)

Depending on model selected the following cable entries are supported (options see pos 23 on page 10):

Version:	Cable entries:
CE/ ATEX/ IEC-Ex/ TR-CU (pos.2 0,W,A,E)	M20 x 1.5 (1x cable gland + 1x blind plug)
FM (pos.2 M,N)	NPT ½" tapered ANSI B1.20.1 (1x open conduit + 1x blind plug)

Dimensions

see page 13

Application up to 150°C (302°F)

- 1 without extended socket
- 2 with extended socket

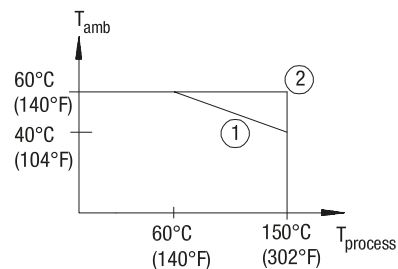
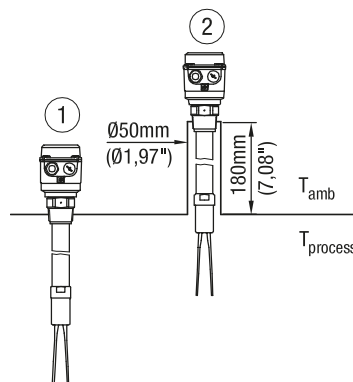

VN 4040 Pipe extension (screwed)

Basic type

VN 4040 ●

pos.2

Certificate

- 0 CE⁽¹⁾ ●
- W ATEX II 1/2D Ex ta/tb IIIC T! Da/Db ●
- A IEC-Ex ta/tb IIIC T! Da/Db ●
- M FM General Purpose ●
- N FM DIP Cl. II, III Div.1 Group E, F, G ●
- E TR-CU Ex ta/tb IIIC T! Da/Db X ●

pos.4

Electronic module

- L Relay DPDT 19 .. 230 V AC 19 .. 40 V DC ●
- D PNP 18 .. 50 V DC ●

pos.5

Process connection

- A Thread R 1½", conical EN 10226 ● ●
- B Thread NPT 1½", conical ANSI B1.20.1 ● ●
- P Triclamp 2" (DN50) ISO 2852 ● ●
- L Flange DN100 PN6, EN 1092-1 (max. 6 bar (87 psi)) ● ●
- M Flange DN100 PN16, EN 1092-1 ● ●
- S Flange 2" 150lbs ANSI B16.5 ● ●
- T Flange 3" 150lbs ANSI B16.5 ● ●
- U Flange 4" 150lbs ANSI B16.5 ● ●

pos.7

Length of extension "L"

- L 1,500 mm (59") (cutable cable length) ●
- M 4,000 mm (157") (cutable cable length) ●

pos.8

Material of process connection/ extension "L"

- 1 Stainless steel 1.4305 (303)/ Flange 1.4541 (321) ●
- 2 Stainless steel 1.4571 (316Ti)/ 1.4404 (316L) ●

Further options: see page 10

VN 4040	C	1		3				
----------------	----------	----------	--	----------	--	--	--	--

position 1 2 3 4 5 6 7 8

← **Order code**

All positions are available in special design (use code "Z").

⁽¹⁾ TR-CU (general purpose) included

Options

- pos.11 x **Guarantee extension to 5 years** •
- pos.21 **Weather protection cover** •
 (for Ex only approved for Zone 22 or Div. 2)

Mounting set for flange mounting

	process connection flange	for counter flange with	consists of				
			screws*	nuts*	washers*	sealing**	
pos.22 c	L	hole ø18	4x M16 x 60	4x M16	4 pcs	1 piece	•
pos.22 d	L	thread M16	4x M16 x 40		4 pcs	1 piece	•
pos.22 e	M	hole ø18	8x M16 x 60	8x M16	8 pcs	1 piece	•
pos.22 f	M	thread M16	8x M16 x 40		8 pcs	1 piece	•

* material stainless steel A2 **max. 125°C (256°F), material not food grade

Cable entry

Selection of the following options only necessary, if a deviation from the default cable gland/ conduit is required:

- pos.23 x M20 x 1.5 2x screwed cable gland •
- pos.23 y M20 x 1.5 1x screwed cable gland +1x blind plug •
- pos.23 a NPT 1/2" tapered ANSI B1.20.1 (1x conduit + 1x Ex-d blind plug) •
- pos.23 b NPT 3/4" tapered ANSI B1.20.1 (1x conduit + 1x Ex-d blind plug) on request

Sliding sleeve ⁶

Process connection as follows or flange as chosen

³ For applications without overpressure, max. 150°C (302°F)

- pos.25 a R 1 1/2" EN 10226 material 1.4301 (304) •
- pos.25 b NPT 1 1/2" ANSI B1.20.1 material 1.4301 (304) •
- pos.25 c Flange ⁵ material 1.4301 (304)/ 1.4541 (321) •

For applications with overpressure max. 16 bar (232 psi), max. 150°C (302°F)

- pos.25 e R 1 1/2" EN 10226 material 1.4571 (316 TI) •
- pos.25 f NPT 1 1/2" ANSI B1.20.1 material 1.4571 (316 TI) •
- pos.25 g Flange ⁵ material 1.4571 (316TI)/ 1.4404 (316L) •

Signal lamp

- pos.27 a Bulb, mounted in cable entry M20 x 1.5, 2W green ¹ •
- pos.27 c Bulb, mounted in cable entry M20 x 1.5, 2W red ¹ •
- pos.27 b LED (glass window in lid)⁴ •

- pos.29 **Plug 4-pole ² (incl. PE)** •

¹ Available for CE (pos.2 0), not in combination with weather protection cover (pos.21) and cable entries pos.23 x,a,b.
 For electronic module Relais DPDT (pos.4 L) three bulbs (24 V, 115 V and 230 V) will be delivered. For PNP (pos.4 D) a 24 V bulb will be delivered.

² Available for CE (pos.2 0)

³ Available for CE and FM/ CSA general purpose (pos.2 0,M)

⁴ Not in combination with weather protection cover (pos.21)

⁵ Flange as selected in pos.5

⁶ Available for VN 4030

Options

pos.21
Weather protection cover

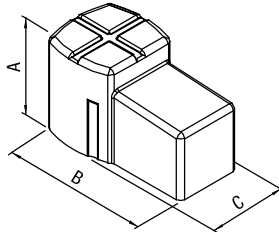

A	100 mm (3.94")
B	165 mm (6.5")
C	88 mm (3.46")

pos.25
Sliding sleeve

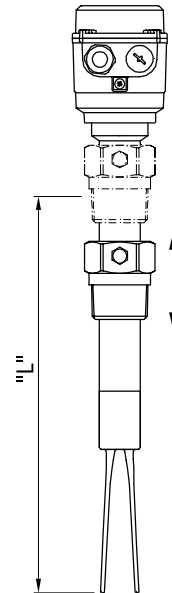

pos.29
Plug 4-pole

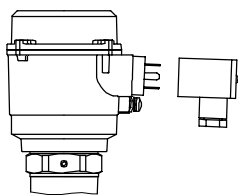

Signal lamp

pos.27 a,c
 Bulb, mounted in
 cable entry M20x1.5

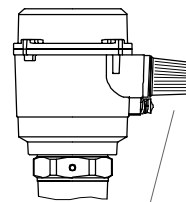

bulb

pos.27 b
 LED (glass window in lid)

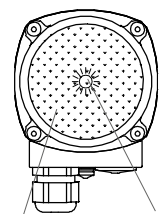

glass window

LED

Dimensions

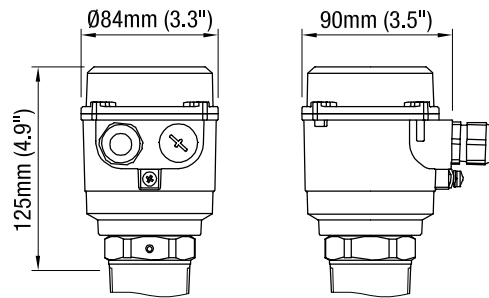

VN 4020

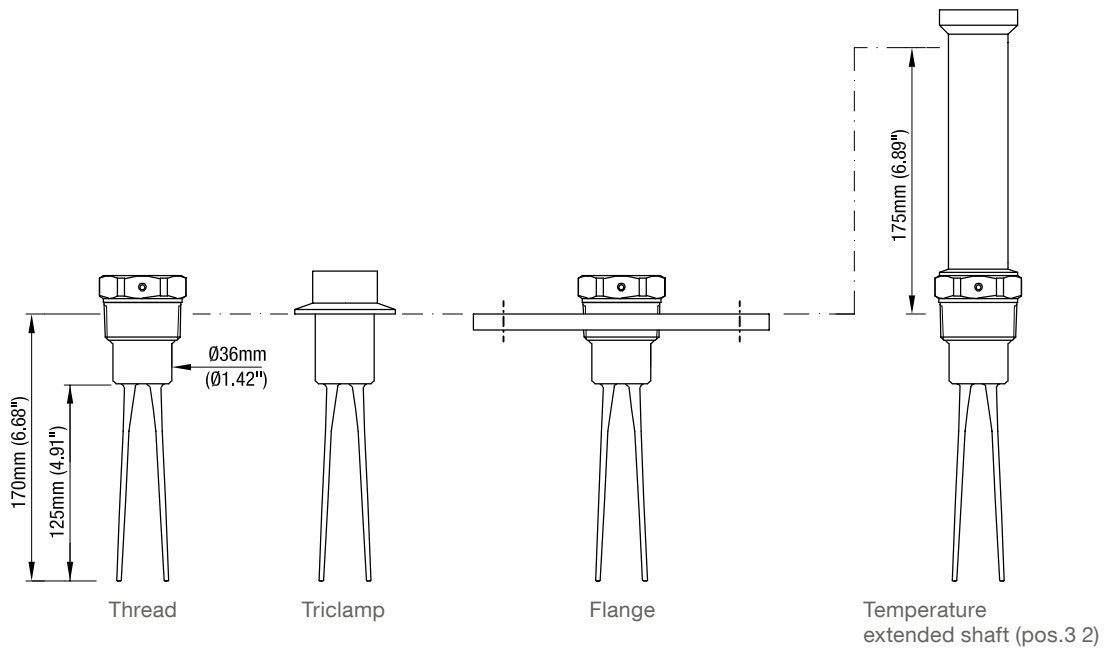

VN 4030

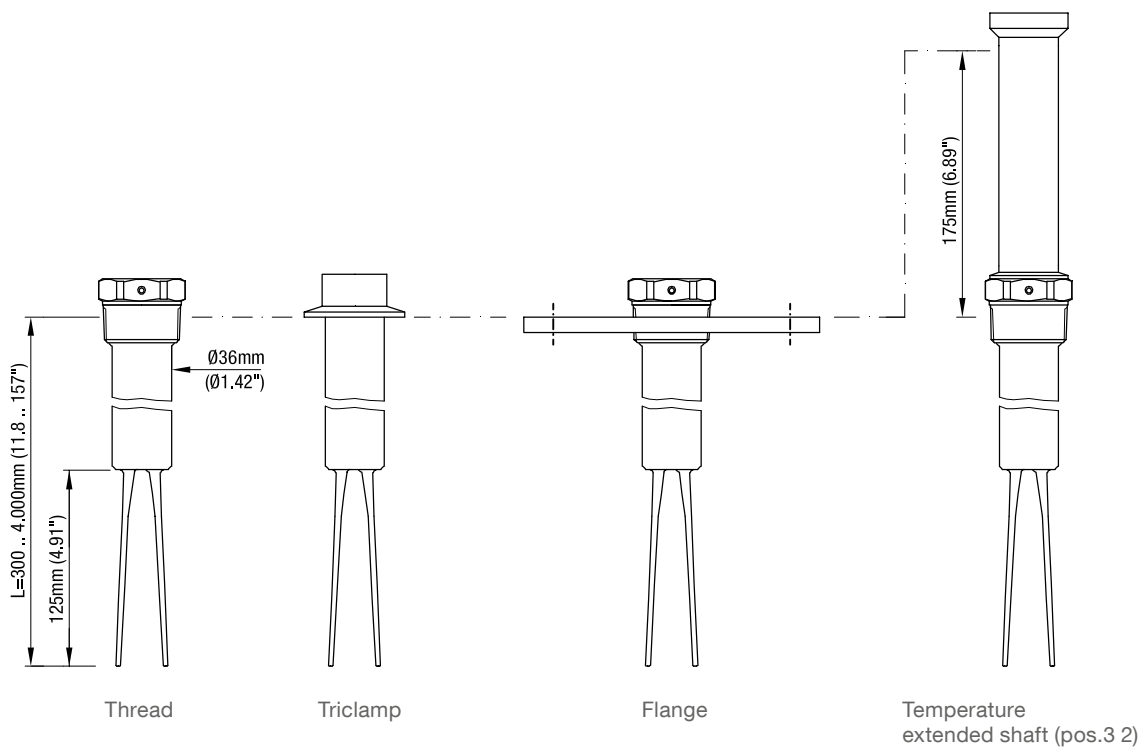

Dimensions / Spare parts

VN 4040

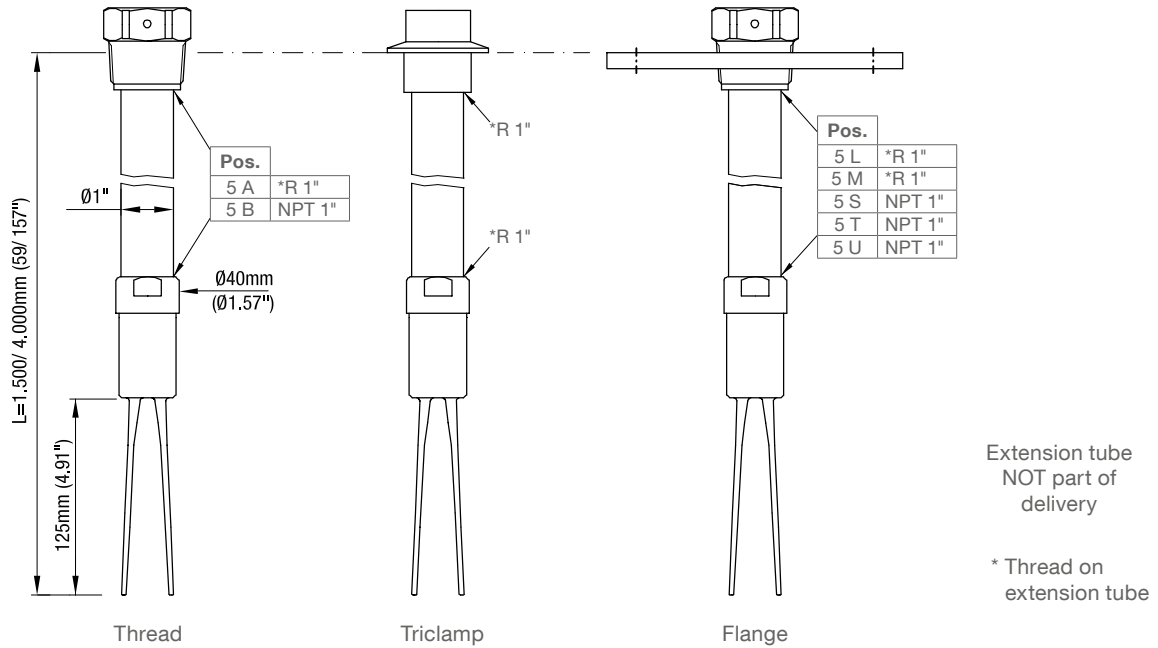

Flanges

code	type	number of holes	d2	Lk	D	T (thickness)
L	flange DN100 PN6	4	18 mm (0.71'')	170 mm (6.69'')	210 mm (8.27'')	16 mm (0.63'')
M	flange DN100 PN16	8	18 mm (0.71'')	180 mm (7.09'')	220 mm (8.66'')	20 mm (0.79'')
S	flange 2" 150lbs	4	19.1 mm (0.75'')	120.7 mm (4.75'')	152.4 mm (6.01'')	19.1 mm (0.75'')
T	flange 3" 150lbs	4	19.1 mm (0.75'')	152.4 mm (6.01'')	190.5 mm (7.5'')	23.9 mm (0.94'')
U	flange 4" 150lbs	8	19.1 mm (0.75'')	190.5 mm (7.5'')	228.6 mm (9.0'')	23.9 mm (0.94'')

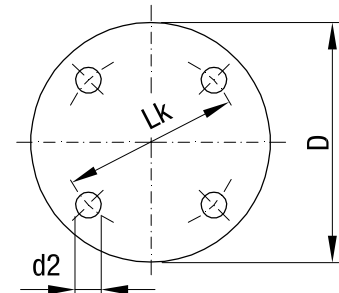

Spare parts

Electronic board	Article number	Price
Relais DPDT 19 .. 230 V AC 9 .. 50 V DC	pl408265	•
PNP 18 .. 50 V DC	pl408266	•

Electronic board

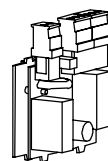

Fitting for housing

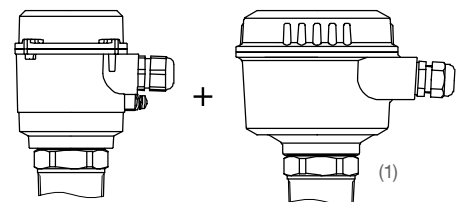

(1) Adapting plate included

Electrical installation

Universal voltage

Relay DPDT

Power supply:

19 .. 230 V 50 - 60 Hz $\pm 10\%$ * 22 VA
 19 .. 40 V DC $\pm 10\%$ * 2 W
 *incl. $\pm 10\%$ of EN 61010

Fuse on power supply:
 max. 10 A, fast or slow, HBC, 250 V

Signal output:

Floating relay DPDT

AC max. 250 V, 8 A, non inductive
 DC max. 30 V, 5 A, non inductive

Fuse on signal output:
 max. 10 A, fast or slow, HBC, 250 V

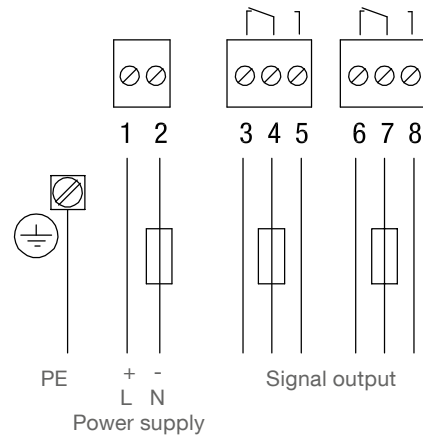

3-wire

PNP

Power supply:

18 .. 50 V DC $\pm 10\%$ *
 *incl. $\pm 10\%$ of EN 61010
 Input current: max. 0.5 A

Fuse:
 max. 4 A, fast or slow, 250 V

Signal output:

max. 0.4 A
 Output voltage equal to input
 voltage, drop < 2.5 V

Load for example:
 PLC, relay, contactor, bulb

